

User's Guide

Agilent Technologies

ESA-E Series Spectrum Analyzers

Option 227

Cable TV Measurement Personality

**This manual applies to Cable TV Measurement Personality version A.02.00.
This manual provides documentation for the following instruments:**

ESA-E Series

E4401B (9 kHz - 1.5 GHz)
E4402B (9 kHz - 3.0 GHz)
E4404B (9 kHz - 6.7 GHz)
E4405B (9 kHz - 13.2 GHz)
E4407B (9 kHz - 26.5 GHz)



Agilent Technologies

Manufacturing Part Number: E4401-90228

Printed in USA

July 2000

© Copyright 2000 Agilent Technologies

Notice

The information contained in this document is subject to change without notice. Agilent Technologies makes no warranty of any kind with regard to this material, including but not limited to, the implied warranties of merchantability and fitness for a particular purpose. Agilent Technologies shall not be liable for errors contained herein or for incidental or consequential damages in connection with the furnishing, performance, or use of this material.

Agilent Technologies assumes no responsibility for the use or reliability of its software on equipment that is not furnished by Agilent Technologies.

Restricted Rights Legend

Use, duplication, or disclosure by the U.S. Government is subject to restrictions as set forth in subparagraph (c)(1)(ii) of the Rights in Technical Data and Computer Software clause at DFARS 252.227-7013 for DOD agencies, and subparagraphs (c)(1) and (c)(2) of the Commercial Computer Software Restricted Rights clause at FAR 52.227-19 for other agencies.

Agilent Technologies
1400 Fountaingrove Parkway
Santa Rosa, CA 95403, U.S.A.

Warranty Information

IMPORTANT

Certification

Agilent Technologies certifies that this product met its published specifications at the time of shipment from the factory. Agilent Technologies further certifies that its calibration measurements are traceable to the United States National Institute of Standards and Technology (NIST, formerly NBS), to the extent allowed by the Institute's calibration facility, and to the calibration facilities of other International Standards Organization members.

NOTE

The actual warranty on your instrument depends on the date it was ordered as well as whether or not any warranty options were purchased at that time. To determine the exact warranty on your instrument, contact the nearest Agilent Technologies sales or service office with the model and serial number of your instrument. See the list of sales and service offices in this document.

This Agilent Technologies instrument product is warranted against defects in material and workmanship for the warranty period. During the warranty period, Agilent Technologies will, at its option, either repair or replace products which prove to be defective.

If the warranty covers repair or service to be performed at the Buyer's facility, then the service or repair will be performed at the Buyer's facility at no charge within Agilent Technologies service travel areas. Outside Agilent Technologies service travel areas, warranty service will be performed at Buyer's facility only upon Agilent Technologies prior agreement, and Buyer shall pay Agilent Technologies round-trip travel expenses. In all other areas, products must be returned to a service facility designated by Agilent Technologies.

If the product is to be returned to Agilent Technologies for service or repair, it must be returned to a service facility designated by Agilent Technologies. Buyer shall prepay shipping charges to Agilent Technologies and Agilent Technologies shall pay shipping charges to return the product to Buyer. However, Buyer shall pay all shipping charges, duties, and taxes for products returned to Agilent Technologies from another country.

Agilent Technologies warrants that its software and firmware designated by Agilent Technologies for use with an instrument will execute its programming instructions when properly installed on that instrument. Agilent Technologies does not warrant that the operation of the instrument, or software, or firmware will be uninterrupted or error-free.

Limitation of Warranty. The foregoing warranty shall not apply to defects resulting from improper or inadequate maintenance by Buyer, Buyer-supplied software or interfacing, unauthorized modification or misuse, operation outside of the environmental specifications for the product, or improper site preparation or maintenance.

NO OTHER WARRANTY IS EXPRESSED OR IMPLIED. AGILENT TECHNOLOGIES SPECIFICALLY DISCLAIMS THE IMPLIED WARRANTIES OF MERCHANTABILITY AND FITNESS FOR A PARTICULAR PURPOSE.

EXCLUSIVE REMEDIES

THE REMEDIES PROVIDED HEREIN ARE BUYER'S SOLE AND EXCLUSIVE REMEDIES. AGILENT TECHNOLOGIES SHALL NOT BE LIABLE FOR ANY DIRECT, INDIRECT, SPECIAL, INCIDENTAL, OR CONSEQUENTIAL DAMAGES, WHETHER BASED ON CONTRACT, TORT, OR ANY OTHER LEGAL THEORY.

Getting Started

What You Will Find in This Chapter	1-2
Introduction	1-3
Checking the Shipment	1-4
Supported Spectrum Analyzer Requirements	1-5
Licensing the Cable TV Measurement Personality	1-6
Installing the Cable TV Measurement Personality	1-7
Uninstalling the Cable TV Measurement Personality	1-8

Measurements

What You Will Find in This Chapter	2-2
Making Channel Measurements	2-3
Step 1. Configure the test system	2-4
Configuration Procedures	2-4
User Defined Channel	2-6
Measurement Bandwidth	2-6
External Preamplifier	2-7
External Pad Compensation	2-7
Step 2. Connect the signal to the analyzer	2-8
Step 3. Make the measurements	2-9
Optimizing the Dynamic Range	2-14
Optimizing the Total Power at the Input	2-14
Access the TV Picture Mode (Optional)	2-23
Modifying the Channel Plan	2-24

If You Have a Problem

What You Will Find in This Chapter	3-2
Error Messages	3-3
If the Test Results Are Not What You Expected	3-4
How to Contact Agilent Technologies	3-5

Channel Measurements Menu Map

What You Will Find in This Chapter	4-2
Channel Measurements Menu Map	4-3

SCPI Commands

SCPI Commands	5-2
---------------	-----

Test Descriptions

What You Will Find in This Chapter	6-2
Visual Carrier Level and Visual-to-Aural Level and Frequency Difference Test Description	6-3
Carrier-to-Noise Ratio Test Description	6-6
Composite Second Order (CSO) Test Description	6-11
Composite Triple Beat (CTB) Test Description	6-14
Hum Test Description	6-16
Depth of Modulation Test Description	6-19

Specifications and Test Aids

What You Will Find in This Chapter	7-2
Cable TV Measurement Specifications and Characteristics	7-3
C/N, CSO, and CTB Measurements	7-6
Channel Identification Plans	7-8

Safety and Regulatory Information

Introduction	8-2
Cleaning Instructions	8-2
Shipping Instructions	8-2
Before Applying Power	8-2
Safety Information	8-3
Warnings	8-3
Cautions	8-4
Instrument Markings	8-5
Safety, Earth, Ground	8-5
Agilent Technologies Sales and Service Offices	8-6

What You Will Find in This Chapter

This chapter provides step-by-step procedures for setting up a spectrum analyzer to perform cable TV measurements. This chapter contains the following sections:

- Introduction
- Checking the Shipment
- Supported Spectrum Analyzer Requirements
- Licensing the Cable TV Measurement Personality
- Installing the Cable TV Measurement Personality
- Uninstalling the Cable TV Measurement Personality

Introduction

With the Agilent Technologies ESA E-Series with Option 227 your spectrum analyzer is both a full-featured spectrum analyzer and a cable TV service and installation analyzer.

The cable TV mode is used to perform channel-by-channel measurements. This allows execution of a single measurement on a single channel.

Checking the Shipment

Verify that the following items are in this shipment. Contact your nearest Agilent Technologies sales or service office. (Refer to the [Agilent Technologies Sales and Service Offices](#) on page 8-6) if any items are missing or damaged.

Table 1-1 **ESA Option 227 Materials Supplied**

Description	Agilent Technologies Part Number	Quantity
ESA Option 227 Cable TV Measurement Personality User's Guide	E4401-90228	1
Personality (Version A.02.00) (provided on 3.5-inch floppy disks)	E4401-10006	1

Supported Spectrum Analyzer Requirements

The ESA Option 227 is designed to operate with 75 Ω and 50 Ω ESA-E Series spectrum analyzers.

Licensing the Cable TV Measurement Personality

In order to start using the features of the Cable TV Measurement Personality, it must be licensed. To license your Cable TV Measurement Personality:

NOTE

If you ordered the Cable TV Measurement Personality with a new spectrum analyzer proceed to step 5 of the [Installing the Cable TV Measurement Personality](#)” on page 1-7, and verify that the program is already installed.

1. Turn the spectrum analyzer on. After the analyzer has completed its power on sequence. Press **System, Licensing**.
2. Press **Option** and use the alpha editor keys to enter the name of the option. For the Cable TV Measurement Personality the option name is 227.
3. Press **Return** to go back to the licensing menu and select **License Key** . Use the numeric keypad and the alpha editor keys to enter the appropriate licensing key for your spectrum analyzer.
4. Press **Return** to return to the licensing menu and press **Activate** to license your installed personality.

Installing the Cable TV Measurement Personality

The Cable TV Measurement Personality is supplied on a floppy disk. To install the program into your spectrum analyzer:

1. Press **System, Personalities**.

The screen will list the personalities currently installed in your analyzer.

2. Insert the Cable TV Measurement Personality floppy disk into the analyzer disk drive and press **Install**. The installer utility will ask if you wish to install now or verify the disk. Press **Install Now** to install the personality.
3. After the installation has been completed press **Exit Installer** to go back to the analyzer mode and cycle the power to the analyzer.
4. To verify that the Cable TV Measurement Personality has been properly installed, press **MEASURE** and check that the last key is labeled **CATV**.

Uninstalling the Cable TV Measurement Personality

To uninstall the Cable TV Measurement Personality from the spectrum analyzer follow these steps:

1. Press **System, Personalities**.
2. Press **Uninstall** and using the up ↑ and down ↓ arrows select the “Cable TV Meas. Pers.” field.
3. Press **Uninstall Now**. The analyzer will ask you to confirm the command by pressing **Uninstall Now** again. After the confirmation the Cable TV personality will be uninstalled.

2 **Measurements**

What You Will Find in This Chapter

This chapter contains information describing how to make cable TV measurements and how to modify channel plans.

The tests are listed on the following pages along with the keys that activate them.

Making Channel Measurements

This section explains the steps that are necessary to make channel measurements. The steps are as follows:

1. Configure the test system
2. Connect the signal to the analyzer
3. Make the measurements

NOTE

Early versions (before personality version A.01) required that each measurement must be turned off prior to changing the channel. Press **Meas Off** to turn off the measurement.

To speed up the testing process the newer personality version allows changing the channels after the measurement has produced a result.

Table 2-1

Channel Measurements

To activate	Press
Carrier Level and Frequency	Carrier Lvl
Carrier to Noise	C/N Ratio
Composite Second Order/Composite Triple Beat	CSO/CTB
Hum	Hum
Depth of Modulation	Depth Mod

Step 1. Configure the test system

Use **MEASURE, CATV, Setup, TVSTD** to set up TV standard, channel tuning, a user defined channel, and an external preamplifier.

NOTE An additional way to set the TV standard is provided if TV Trigger (Option B7B) is installed. This method is by pressing keys **Trig, TV Trig Setup, Standard**. The two methods of setting the TV standard work independently of each other. However, when a CATV measurement is started, whatever standard is set under the **Trig** menu is changed to match the standard that was set under **MEASURE**. Therefore, it is important that **MEASURE, CATV, Setup, TVSTD** is used to set the TV standard before starting CATV measurements.

NOTE The information is stored in nonvolatile analyzer memory. This means that the analyzer retains the information, even when the power is turned off, until you access the setup menu again and change it.

Configuration Procedures

1. Press **MEASURE, CATV, Setup**.

NOTE The default TV standard is set to NTSC-M.

2. Press **TVSTD** and choose the appropriate TV standard: NTSC-M, NTSC-J, PAL-M, PAL-B/G, PAL-D/K, or PAL-I (the default TV standard is set to NTSC-M).
3. Press **Plan** and the appropriate channel plan key.

NOTE The channel plan that is shown in the menu will depend on which TV standard was enabled in step 2. For example, if the TV standard NTSC-M was enabled in step 2 then the channel plan menu would display the following selections: STD, AIR, IRC, HRC, and T, but would not show the CBL, VHF, or other channel plans.

The default configuration menu allows you to select one of the following channel formats:

- NTSC-M and PAL-M channel plans
 - STD Standard Cable
 - AIR Broadcast Channels
 - HRC HRC Cable
 - IRC IRC Cable
 - T Upstream Channels

- NTSC-J
 - CBL Japan Standard Cable
 - AIR Japan Broadcast channels
- PAL-B/G
 - HRC HRC Cable
 - VHF VHF Channels
 - UHF UHF Channels
 - S S Channels PAL-B/G Standard
 - S-Cable S Channels PAL-B/G Cable
 - CENELEC CENELEC Channels
- PAL-D/K
 - DS China Broadcast Channels
 - Z China Standard Cable
- PAL-I
 - HRC HRC Cable
 - VHF VHF Channels
 - UHF UHF Channels

Measurements

Making Channel Measurements

User Defined Channel

The following keys in the setup menu allow you to define the center frequency and span for a user defined channel. This channel is then accessed by selecting channel 0 (zero). Refer to [Figure 2-1](#).

- **Chan 0 Freq** Channel 0 center frequency
- **Chan 0 Span** Channel 0 span

One convenient use for Channel 0 is for testing at 44 MHz IF.

Figure 2-1

Channel Tuning Menu

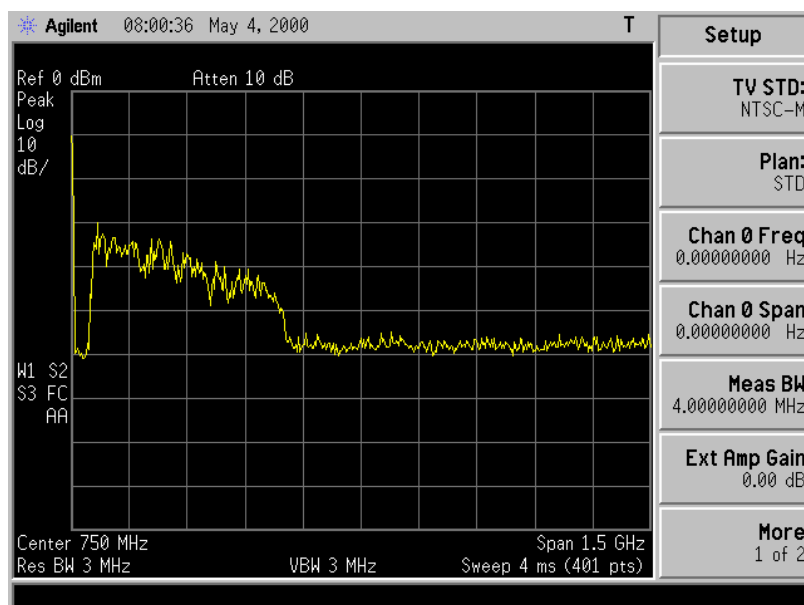

Measurement Bandwidth

Measurement Bandwidth carrier to noise, bandwidth default is 4 MHz for NTSC-M, NTSC-J and PAL-M.

NOTE

Bandwidth default for PAL-I, PAL-B/G and PAL-D/K is 5 MHz.

External Preamplifier

1. *Using an external preamplifier, for analyzers without an internal preamplifier:*
An external preamplifier may be required for the carrier-to-noise test. See Chapter 6, “Test Descriptions,” which contains more information about when a preamplifier is required for the carrier-to-noise test. The carrier-to-noise test calculates the noise contribution of the external preamplifier, and reports the correction on the **More Info** screen of the carrier-to-noise test. If an external preamplifier is used, enter the preamplifier gain and noise figure using **Ext Amp Gain** and **Ext Amp NZ Fig** in the **Setup** menu.

NOTE

Inaccurate values used for **Ext Amp Gain** and **Ext Amp NZ Fig** can result in significant measurement errors. Use Agilent 85905A preamplifier with measured data for accurate results.

NOTE

If an external preamplifier is not used, **Ext Amp Gain** and **Ext Amp NZ Fig** values must be set to zero or carrier-to-noise ratio calculation errors may occur.

2. Connect the cable TV signal as described in [“Step 2. Connect the signal to the analyzer” on page 2-8.](#)

External Pad Compensation

1. **EXT PAD Yes No** key can be used to compensate for the amplitude loss caused by using a 50 Ω to 75 Ω external matching pad. (A 50 Ω to 75 Ω external matching pad is used to match the signal from a 75 Ω impedance system to a spectrum analyzer with a 50 Ω impedance input.) The external pad function compensates for the 5.8 dB amplitude loss of the external pad by setting the spectrum analyzer's reference level offset to 5.8 dB.
2. If you are using a spectrum analyzer with 50 Ω input impedance but are not using an external matching pad, the cable TV analyzer mode will compensate for most of the impedance mismatch, but amplitude measurements can have up to ± 0.2 dB error caused by the uncompensated mismatch over the frequency range.

This function is set to **No** when the ESA Option 227 personality is loaded into analyzer memory.

The setting of the external pad function is stored in nonvolatile spectrum analyzer memory. Storing the setting in nonvolatile memory means that once the external pad function is set to **Yes**, it will remain set to **Yes** until you change the setting or delete the ESA Option 227 personality program from analyzer memory.

Press **MEASURE, CATV, Setup** to access **Ext Pad Yes No**.

Step 2. Connect the signal to the analyzer

CAUTION

To prevent the analyzer input circuits from being damaged, the total power at the analyzer input must be less than +75 dBmV.

To optimize the analyzer input mixer for the best measurement range without being overloaded, the total power at the analyzer input mixer must be less than +47 dBmV for C/N and less than +37 dBm for CSO/CTB. Total power greater than these will add analyzer attenuation. These values are 10dB greater than the Agilent 8591C Spectrum Analyzer, resulting in more measurement dynamic range using the Agilent ESA analyzer. Compare the accuracy and characteristics graphs of [Figure 7-1 on page 7-7](#) with those of the Agilent 8591C analyzer.

For systems with unequal carrier levels (system tilt), the total power must be calculated by summing the individual carriers. The **Total Power** key function accounts for system tilt.

You can measure the input power by pressing **MEASURE, CATV, Setup, Total Power**. The total power is displayed at the bottom of the screen.

Total power at the input mixer can be reduced by increasing input attenuation. Press **Amplitude, Attenuation** and make the adjustment. The analyzer retains a manually selected attenuation until you either select a new value, or reset the analyzer power-on default conditions. For all tests provided by the cable TV measurement personality, the analyzer automatically selects the attenuator setting to meet the above requirements.

Step 3. Make the measurements

Most measurements update the result at the end of a sweep or at the end of multiple sweeps. Refer to each measurement type.

NOTE

1. If you accidentally use the wrong key sequence, re-enter the channel. Press **MEASURE, CATV, Channel**, enter the channel number, and press **Enter**.
2. If you want to set the analyzer to the power-on default conditions after using the cable TV functions, you can either cycle the power or press **Preset**.

Carrier Level and Frequency Test

1. Select a channel and press **MEASURE, CATV, Carrier Lvl**. The peak visual carrier level and visual-to-aural carrier difference appear on the screen. See [Figure 2-2](#).

Frequencies and power ratios for both sound carriers are displayed when the following TV standards (and associated sound carriers) are used:

- PAL-I with NICAM
- PAL-B/G
- PAL-B/G with NICAM

See [Figure 2-3 on page 2-10](#) and [Figure 2-4 on page 2-11](#).

2. If it is available, press **Nicam On Off (On)**. A true RMS power measurement is made across the NICAM band and the visual-to-sound power ratios are displayed.

NOTE

The **Nicam** key is available only when PAL-I or PAL-B/G has been selected in the **TVSTD** menu. It is not an indication that a NICAM carrier is present in the channel.

3. Press **MEASURE, CATV, Meas Off** to exit the test.
Press **Meas Control** to control single sweep, pause, and restart.

Measurements
Making Channel Measurements

Figure 2-2 Carrier Level Measurement (NTSC-M)

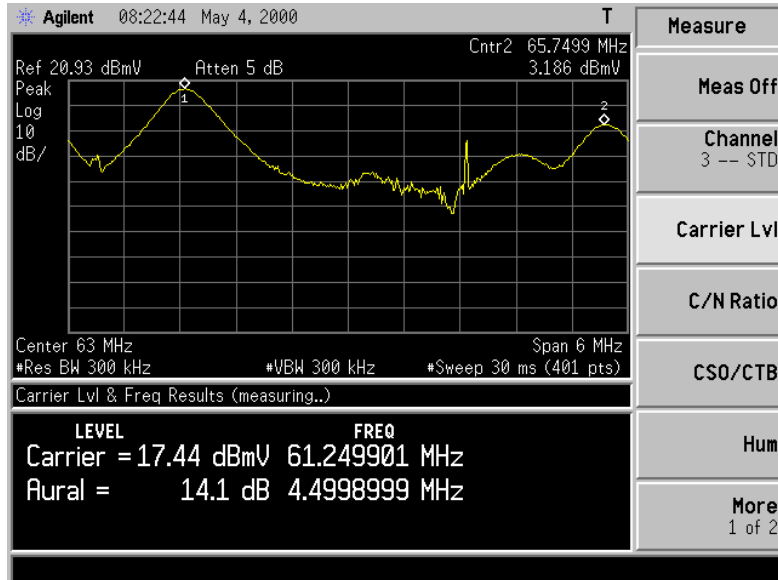

Figure 2-3 Carrier Level Measurement (PAL-B/G with Nicam Off)

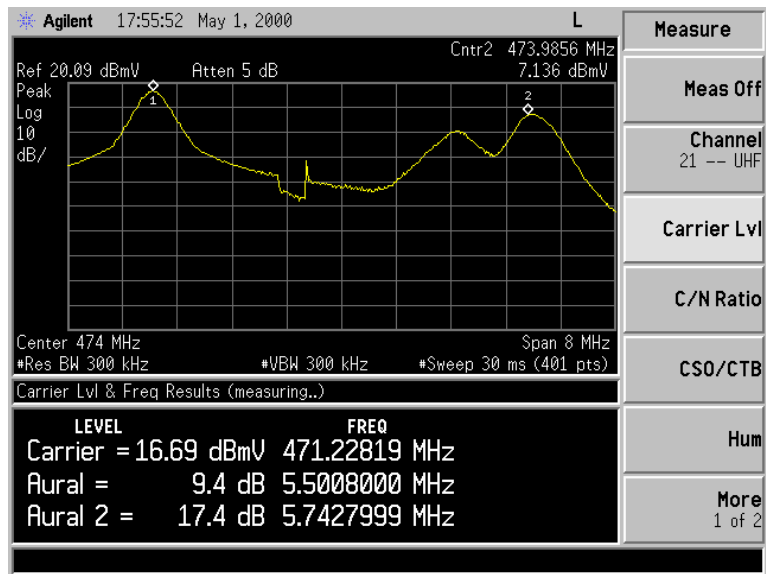
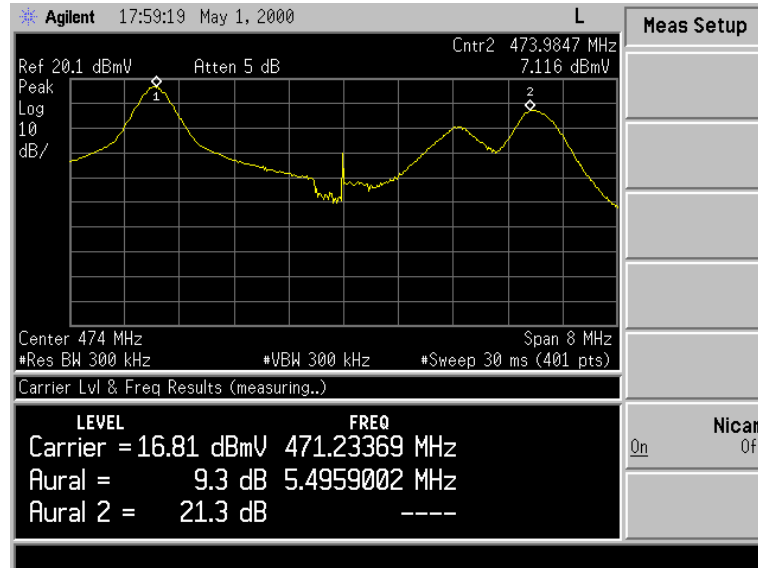

Figure 2-4 Carrier Level Measurement (PAL-B/G with Nicam On)



NOTE

For best results, the carrier-to-noise ratio (in 4 MHz BW or 5 MHz BW) of the system should be 40 dB or greater, and the measured signal level should be 30 dB or greater above the displayed noise during the test.

For sync suppressed scrambled signals the results will be inconsistent. To stabilize the result press **View/Trace, Max Hold**. To exit the test, press **Clear Write** to exit the max hold function then **MEASURE, CATV, Measure Off**. To speed level measurements on a number of channels, a new channel can be tuned during the measurement. Press **Channel**, enter the channel number, and press **Enter** or use the up arrow ↑ or down arrow ↓ to move to adjacent channels.

Carrier-to-Noise Test

1. Select a channel, then press **MEASURE, CATV, C/N Ratio**.
2. Perform the following steps:
 - a. The marker defaults to the minimum system noise near the lower channel boundary. Wait for the analyzer to return an answer.
 - b. Remove the carrier and modulation to perform the carrier-to-noise test.
 - c. Press **Marker**, then using the knob, move the marker to the desired position in the indicated "FCC MEASUREMENT RANGE." Refer to [Figure 2-5 on page 2-12](#).

Measurements
Making Channel Measurements

NOTE

“FCC Measurement Range” is only applied for NTSC-M, NTSC-J and PAL-M TV standards . The message “Measurement Range” will be displayed for the other TV standards. See [Figure 2-6 on page 2-13](#).

The FCC measurement range bandwidth is defined as 4 MHz. Measurement range bandwidths other than the FCC measurement range bandwidth are defined as 5 MHz.

Change the measurement bandwidth by pressing **MEASURE, CATV, Setup, Meas BW**, and enter the desired bandwidth.

- d. Use averaging to stabilize the result. Press **BW/Avg, Averaging On**. Check that the average type is set to video.

The carrier-to-noise test compares the system noise level at the analyzer input to that of the analyzer itself. If these levels are within 3 dB of each other, the analyzer will display the message “See More Info” (under **Meas Setup**) next to the measurement result. If the difference is less than 2.2 dB, the message is in inverse video. Refer to Chapter 6, “Test Descriptions,” for more detailed information about the carrier-to-noise measurement.

- 3. Press **More Info** to display the carrier-to-noise calculation. See [Figure 2-7 on page 2-13](#). To exit the test, press **MEASURE, CATV, Meas Off**.

Figure 2-5 Carrier-to-Noise — FCC Measurement Range (NTSC-M)

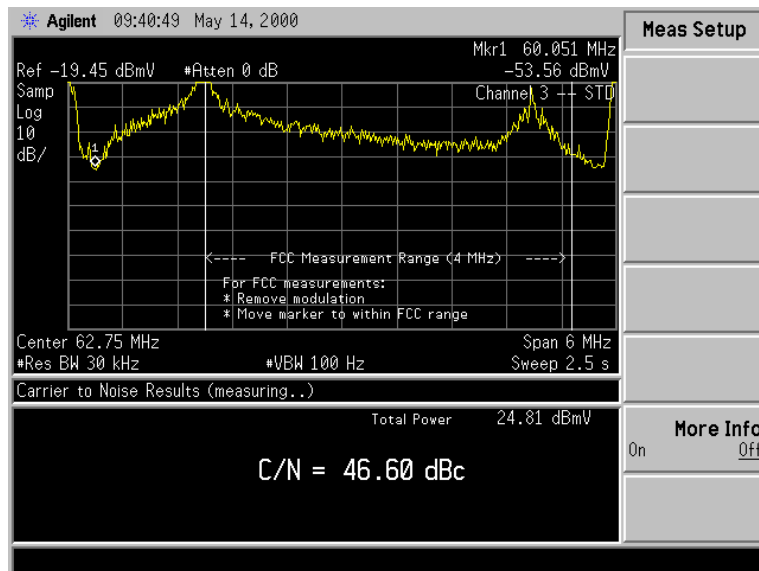

Figure 2-6 Carrier-to-Noise (PAL-B/G)

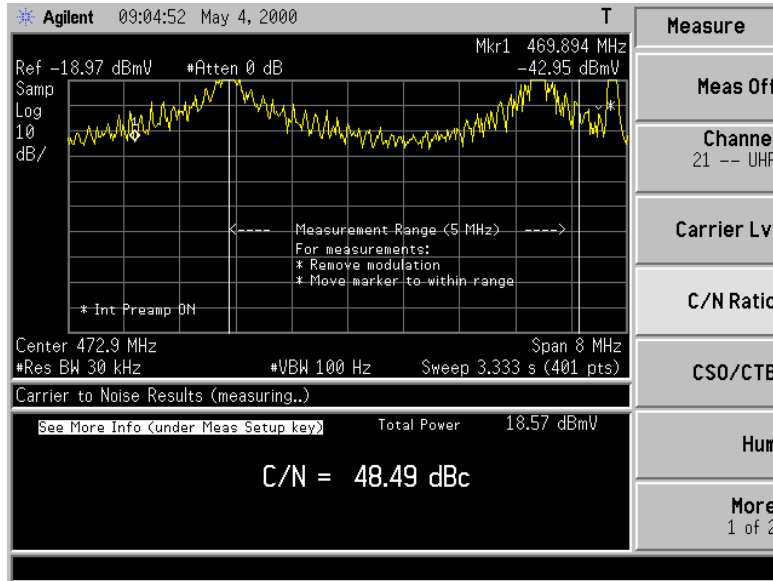
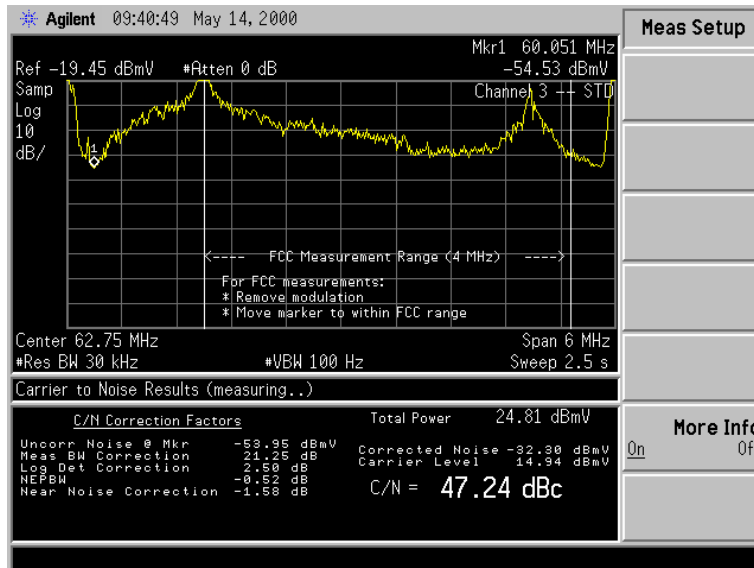

Figure 2-7 Carrier-to-Noise, More Information (NTSC-M)



Carrier to Noise with an External Preamplifier

Preamplifier noise is calculated and corrected when an external preamplifier is used. External preamplifier gain and noise figure are used for this calculation. External preamplifier keys **Ext Amp Gain** and **Ext Amp NZ Fig** are used only for this purpose. Refer to the notes under “[External Preamplifier](#)” on page 2-7 for proper usage.

1. When using a tunable bandpass filter, first peak the filter using the **Carrier Lvl** key. Press **Meas Off, C/N Ratio**. Place the marker to measure the carrier-to-noise close enough to the carrier to minimize any roll-off effect of the bandpass filter.
2. Carrier-to-noise measurement accuracy is degraded as the cable TV system noise approaches the analyzer noise. This is reflected in the magnitude of the analyzer noise correction value.
3. Note the analyzer noise correction value by pressing **More Info**.
 - if less than 0.5 dB, then C/N accuracy is ± 1 dB
 - if equal to 0.5 dB, then C/N accuracy is ± 1.25 dB
 - if equal to 3 dB, then C/N accuracy is ± 2 dB
 - if equal to 7 dB, then C/N accuracy is ± 3.5 dB
 - if greater than 7 dB, C/N is out of measurement range
4. The analyzer input attenuator sets the noise floor of the analyzer. The attenuator is set to not overload the first mixer. For carrier to noise, the attenuator switch point from 0 to 5 dB is at +47 dBmV total power at the input. (This range is 10 dB more than the Agilent 8591C spectrum analyzer.)

Optimizing the Dynamic Range

Limiting the number of carriers input to the analyzer allows the measurement routine to select a lower attenuator value, providing the analyzer a lower noise floor. This can be done with individual channel filters, a high pass filter, a low pass filter or an adjustable bandpass filter.

When the attenuator switches to the next higher value, the noise floor raises 5 dB which degrades the signal to noise ratio by 5 dB. For C/N, the attenuator switches from 0 dB to 5 dB at +47 dBmV. Keeping the total power just below that will obtain the best signal to noise ratio.

A 1 dB (or smaller than 5 dB) step attenuator used in conjunction with a filter will provide the best coverage of signal range for optimizing the total power at the input.

Optimizing the Total Power at the Input

If the analyzer correction value dictates that it is necessary to optimize the analyzer noise floor for a particular configuration, press **MEASURE, CATV, Setup, Total Power**.

For carrier to noise, the attenuator switch point from 0 dB to 5 dB attenuation is at +47 dBmV. The attenuator switch point from 5 dB to 10 dB is at +52 dBmV and increments proportionately with each 5 dB step in attenuation.

Measuring C/N with modulation on is limited to a maximum range of 55 dB. Measuring C/N with modulation off within 2 MHz of the carrier is limited to a maximum range of 55 dB. For a higher maximum C/N range, measure noise farther than 2 MHz from the carrier when the carrier is on, or turn the carrier off. Refer to the graphs shown in [Figure 7-1 on page 7-7](#).

**Composite
Second
Order/Composite
Triple Beat
(CSO/CTB) Test**

1. Select a channel, then press **MEASURE, CATV, CSO/CTB**.
2. Perform the following steps:
 - a. The marker defaults to the lower beat.
 - b. To perform the carrier-to-beats test remove the carrier and modulation by turning the modulator off.

NOTE

The carrier-to-beats test for NTSC-M, NTSC-J, and PAL-M is done according to FCC requirements.

- c. Using the knob, move the marker to the desired beat. See [Figure 2-8 on page 2-17](#). Note that if the marker is not active, you will need to press the **Marker** key. Alternatively, press **Meas Setup, Next Beat**.

NOTE

For NTSC-J, please refer to [Figure 2-9 on page 2-17](#) and for PAL-B/G, PAL-D/K and PAL-I refer to [Figure 2-10 on page 2-18](#).

- d. Turn averaging on by pressing **BW/Avg, Average On**. Check that the averaging type is video. Press **Return** to get back to the cable measure menu.
3. Move the marker to the next beat by pressing **Next Beat**. Using the front-panel knob will also allow measuring beats other than at the standard CSO/CTB offsets.

The results of the measurement are displayed at the bottom of the analyzer display.

4. Press **Meas Setup**, and then **Atten Down** or **Atten Up**, to make the attenuator check for analyzer generated beats when not using a bandpass filter. Switch the attenuator up and down to check for changes in the beat level.

If the beat level does not change, then the beat is not generated in the analyzer. If the beat level changes with attenuator changes, then raise the attenuator setting until the beat level no longer changes. The displayed noise may prevent accurate measurement results.

Measurements
Making Channel Measurements

NOTE The measurement automatically sets the attenuator to prevent analyzer generated beats upon entering the test. The analyzer switches from 0 dB attenuation to 5 dB attenuation at +37 dBmV of total power at the input.

- Remove the carrier, or press **CTB Up** or **CTB Down** to measure the CTB above or below the carrier (if an open space exists). Each time **CTB Up** is pressed, the marker is automatically positioned at the next CTB above the carrier (+6 MHz increments). Each time **CTB Down** is pressed, the marker is automatically positioned at the next CTB below the carrier (−6 MHz increments).

NOTE ±6 MHz increments only are applied for NTSC-M, NTSC-J and PAL-M TV standards. PAL-B/G, PAL-D/K and PAL-I will have ±7 MHz or ±8 MHz, ±8 MHz and ±8 MHz increments respectively.

- Press the **More Info** key to display the carrier-to-beat calculation. To exit the test, press **MEASURE, CATV, Meas Off**.

NOTE When using a tunable bandpass filter, first peak the filter using **Carrier Lvl**. Make sure the filter bandwidth is sufficient that the beats are not rolled off. See [Table 2-2](#) below.

Table 2-2 Boundary Beats

TV Standard	Lowest Beat (MHz)	Highest Beat (MHz)
NTSC-M	−1.25	+1.25
NTSC-J	−1.25	+4.00
PAL-M	−1.25	+1.25
PAL-B/G (7 MHz span)	CTB	+5.25
PAL-B/G (8 MHz span)	CTB	+6.25
PAL-D/K	CTB	+6.25
PAL-I	CTB	+6.25

Figure 2-8 CSO/CTB Measurement (NTSC-M)

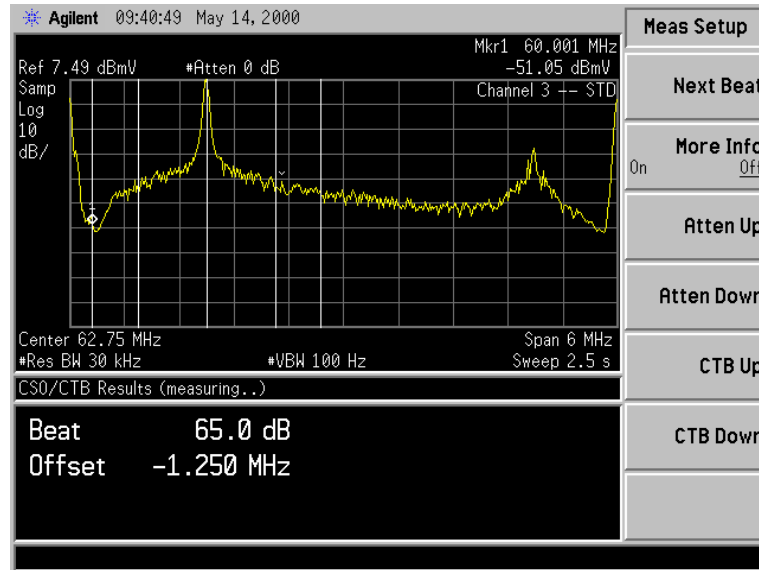

Figure 2-9 CSO/CTB Measurement (NTSC-J)

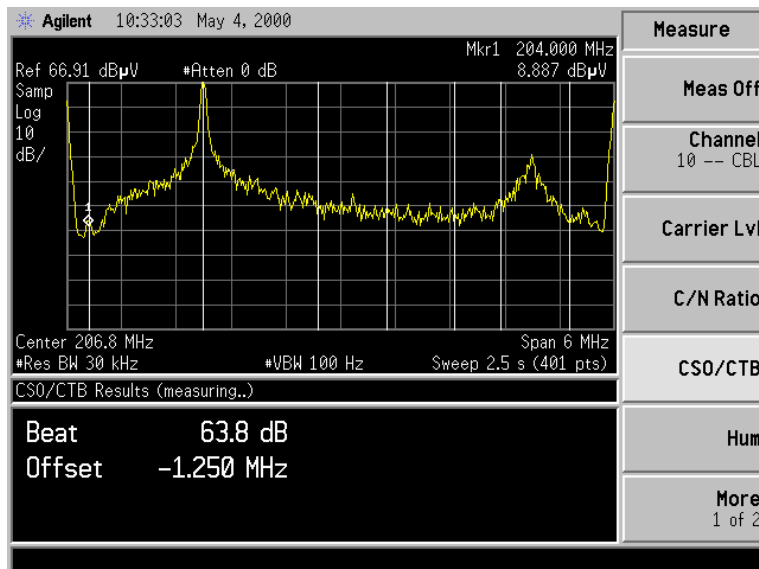
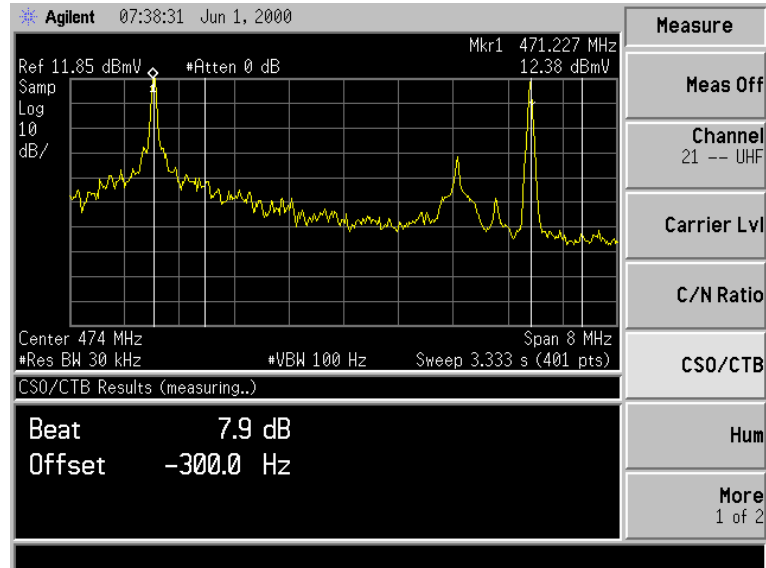

Figure 2-10 CSO/CTB Measurement (PAL-B/G)



NOTE See the graphs, [Figure 7-1 on page 7-7](#), for measurement range versus visual carrier level.

Hum Test

1. Select a channel or tune directly to the carrier to be measured. Make sure that the desired carrier is the highest on the screen by adjusting the center frequency or span as needed. Turn off modulation (optional), then press **MEASURE**, **CATV**, **Hum**. See [Figure 2-11 on page 2-19](#).

NOTE After pressing **Hum**, the analyzer determines if video modulation is present or not. If the video modulation is on and the test result is greater than 3 percent, an additional message appears advising the operator to retest using a CW signal only.

2. Press **More Info** to perform a single sweep and a Fast Fourier Transform (FFT) to separate power line related components. See [Figure 2-12 on page 2-20](#).

60 Hz, 120 Hz, 180 Hz, and 240 Hz are displayed. This is intended to be used as a troubleshooting aid. A relatively high 60 Hz level implies inadequate grounding or stray power utility neutral currents. A relatively high 120 Hz level implies poor filtering of a full-wave rectifier in a power supply.

NOTE For TV standards PAL-B/G, PAL-D/K and PAL-I, 50 Hz, 100 Hz, 150 Hz and 200 Hz are displayed instead. These values also are intended to be used as a troubleshooting aid. A high 50 Hz level implies inadequate grounding or stray power utility neutral currents. A high 100 Hz level implies poor filtering of a full-wave rectifier in a power supply. See [Figure 2-13 on page 2-20](#).

3. To exit the test, press **MEASURE**, **CATV**, **Meas Off**.

NOTE For best results, the channel carrier-to-noise ratio should be 40 dB or greater (in a 4 MHz or 5 MHz noise bandwidth).

The hum test requires a carrier wave. It cannot give meaningful results when a channel uses sync suppression scrambling (unless the measurement is made at the subscriber terminal output of a descrambler). Measuring hum with video modulation present requires that all sync tips have the same general level in order to measure their variation.

Invalid information is given when the hum test is performed on channels with sync suppression scrambling.

Figure 2-11

Hum Measurement (NTSC-M)

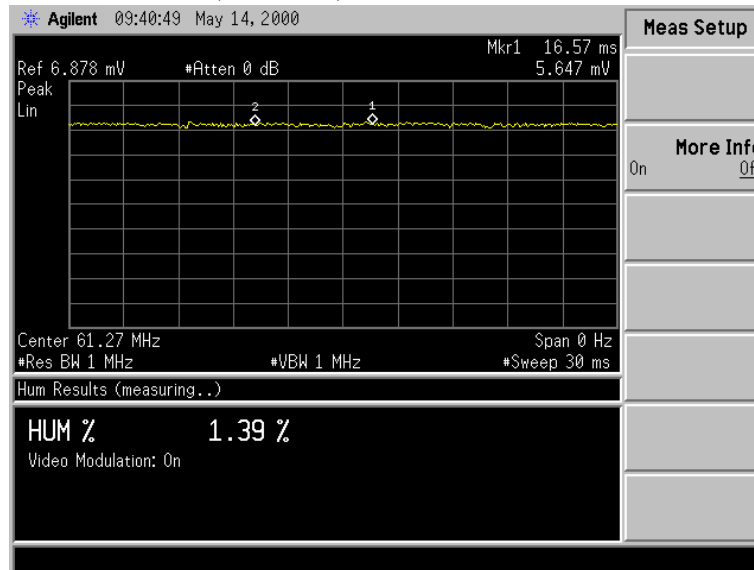

Measurements
Making Channel Measurements

Figure 2-12 Hum, More Information (NTSC-M)

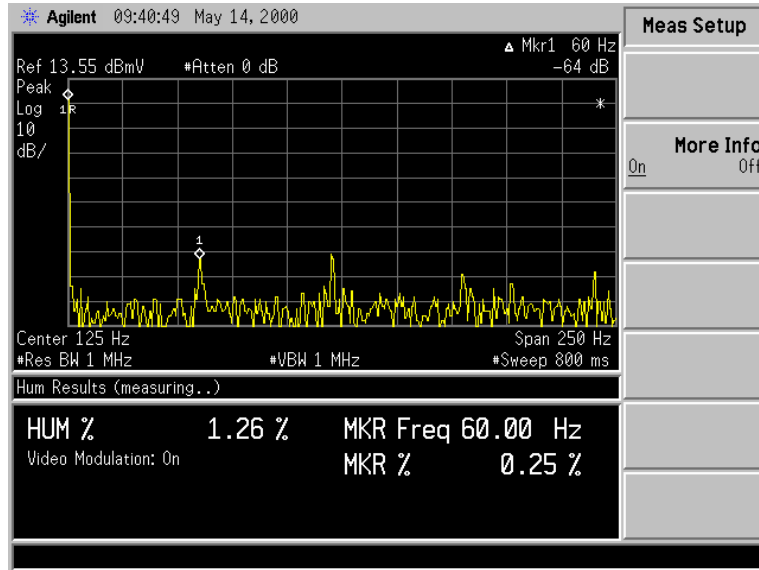
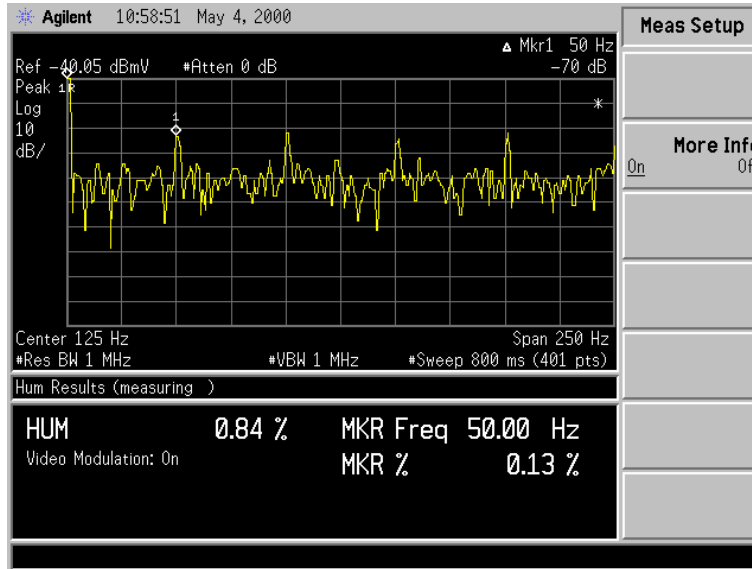

Figure 2-13 HUM, More Information (PAL-B/G)



Depth of Video Modulation Test

1. Select the channel and press **Measure, CATV, Depth Mod**. The result is updated every 50 analyzer sweeps (approximately every 6 seconds). Refer to [Figure 2-14](#).
2. To exit the test, press **MEASURE, CATV, Meas Off**.
3. Press the **Meas Control** key to control single sweep, pause, and restart.

NOTE Large amounts of hum and low frequency disturbances may affect the measurement result. If so use the TV Line optional test.

NOTE This test must have a white level present during the vertical interval because program video may not always have white level available.

4. For spectrum analyzers with TV Trigger (Option B7B) and Fast Time-Domain Sweeps (Option AYX), the test can also be performed on an individual TV line:

a. Press **Meas Setup, TV Line**.

Results are returned approximately every second. This helps when making modulator adjustments.

Figure 2-14 Depth of Video Modulation Measurement (NTSC-M)

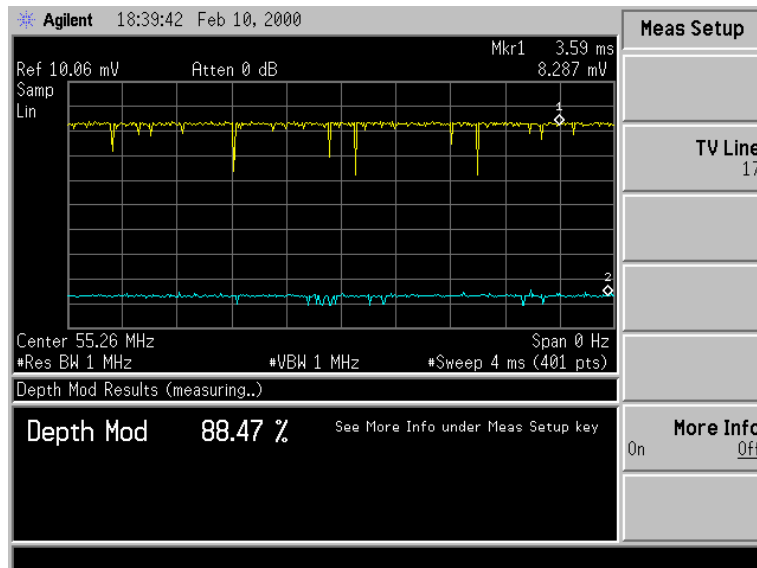

Measurements

Making Channel Measurements

Figure 2-15 TV Line Number (NTSC-M)

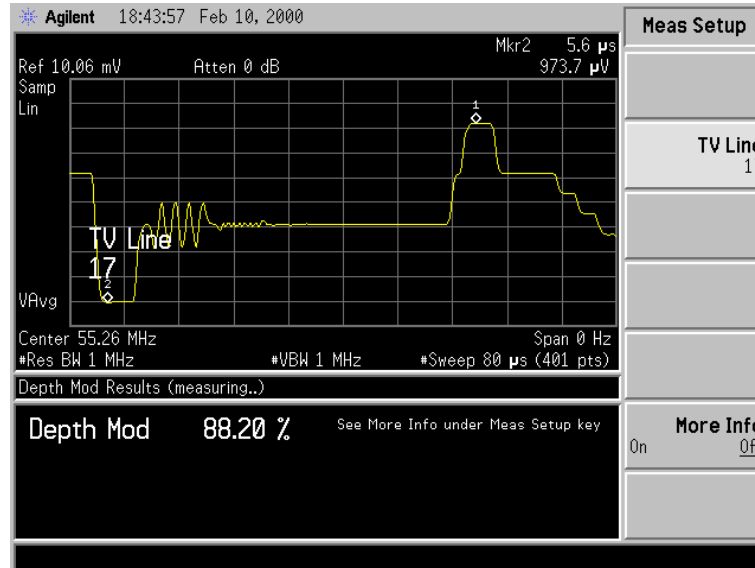

- b. To change the TV line number, either enter the new number and press the **Enter** key, or use the up and down arrow keys (\uparrow and \downarrow) to increment and decrement, respectively, the current line number by one. Refer to [Figure 2-15](#).
- c. To view multiple horizontal lines, change the sweep time by pressing **Sweep, Sweeptime**. Enter the new number then press **ks, s, ms, or μs**. Press **Return** to return to the cable TV menu.

NOTE

The displayed video is inverted from how it would appear on a waveform analyzer (that is, sync is displayed at the top in this test and would be displayed at the bottom with a waveform analyzer).

NOTE

If no white reference is available the test can be changed to a Quiet Line. Ideally, it should read 25%.

1. Press **Meas Setup, More Info** to display the ideal value, and other measurement considerations. Refer to [Figure 2-16 on page 2-23](#).

Figure 2-16 Depth of Video Modulation, More Information (NTSC-M)

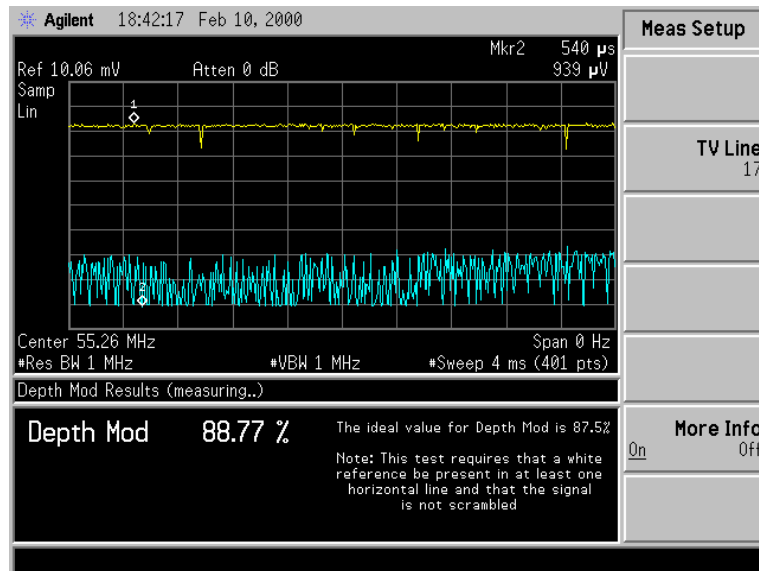

Access the TV Picture Mode (Optional)

1. Select a channel, then press **MEASURE, CATV, Picture**.
2. Press the **Tab** keys to select the desired channel to view. Press the **Tab** |→ key to increment the channel and the **Tab** ←| key to decrement the channel. Pressing almost any other key will exit the TV picture display.
3. To select and view any desired channel press **MEASURE, CATV, Channel**.
4. To exit the mode, press **MEASURE, CATV, Meas Off**.

NOTE

Option B7B is required to access the TV Picture mode.

TV Picture Mode is useful for channel identification. Picture quality is compromised by using the spectrum analyzer resolution bandwidth filters, which are not shaped to reject adjacent channel carriers. This results in herringbone patterns superimposed on the picture.

Modifying the Channel Plan

This section explains the steps that are necessary to change the default channel plan. The steps are as follows:

1. Copy the CTNTSCM.PLN file onto a floppy disk.
2. Edit the CTNTSCM.PLN file
3. Install the CTNTSCM.PLN file

The CTNTSCM.PLN file contains the information necessary to define up to five channel plans. Each channel plan defines the center and span for each of the channels.

NOTE

For TV standards other than NTSC-M, different channel plane files are used. To change these channel plans, follow the above three steps with the channel plan file corresponding to the desired TV standard. See [Table 2-3](#).

Table 2-3**Channel Plan Files**

Channel Plan File	TV Standard	Max Allowed Channel Plan
CTNTSCJ.PLN	NTSC-J	2
CTPALM.PLN	PAL-M	5
CTPALBG.PLN	PAL-B/G	6
CTPALDK.PLN	PAL-D/K	2
CTPALI.PLN	PAL-I	3

Step 1. Copy the CTNTSCM.PLN file onto a floppy disk

1. Insert a formatted (PC environment) floppy disk into the analyzer floppy disk drive.
2. Press **File, Copy**.
3. Select **Type, All** and use the up and down arrow keys (↑ and ↓) to highlight the CTNTSCM.PLN file in the [-C-] directory.
4. Select **Dir To, Dir Select**. Use the up and down arrow keys (↑ and ↓) to highlight the [-A-] drive.
5. Press **Dir Select, Copy Now**. You should now have a copy of the CTNCSTM.PLN file on your floppy disk.
6. Using your PC verify that the floppy disk contains the CTNTSCM.PLN file.

Step 2. Edit the CTNTSCM.PLN File

To edit the CTNTSCM.PLN file, you will need an ASCII text editor and a PC. Refer to the “CTNTSCM.PLN file below. The following notations are used within the file:

- ! – Name of plan
- @ – Start channel
- # – End channel
- \$ x, y – Where x is the center frequency and y is the span
- ; – Comment

NOTE (“...” denotes a break in the file)

NOTE The same notations are used throughout every channel plan file

CTNTSCM.PLN File

- ; This file is the channel plan for NTSC-M
- ; Use the following symbols
- ; ! = Name plan
- ; @ = Start channel
- ; # = End channel
- ; \$ x, y = where x is center frequency, y is span
- ; ; = comment

Measurements
Making Channel Measurements

```
! STD
@ -13
# 158
$ 45250000 , 6000000.000000 ;Channel #-13
$ 39250000 , 6000000.000000 ;Channel #-12
$ 33250000 , 6000000.000000 ;Channel #-11
$ 27250000 , 6000000.000000 ;Channel #-10
$ 21250000 , 6000000.000000 ;Channel #-9
$ 15250000 , 6000000.000000 ;Channel #-8
$ 9250000 , 6000000.000000 ;Channel #-7
$ 0.0000 , 6000000.000000 ;Channel #-6
$ 0.0000 , 6000000.000000 ;Channel #-5
$ 0.0000 , 6000000.000000 ;Channel #-4
$ 0.0000 , 6000000.000000 ;Channel #-3
$ 0.0000 , 6000000.000000 ;Channel #-2
$ 0.0000 , 6000000.000000 ;Channel #-1
$ 45500000.0000 , 6000000.000000 ;Channel #0
$ 51500000.0000 , 6000000.000000 ;Channel #1
$ 57500000.0000 , 6000000.000000 ;Channel #2
$ 63500000.0000 , 6000000.000000 ;Channel #3
```

```
.
.
.
! AIR
@ -13
# 158
$ 45250000 , 6000000.000000 ;Channel #-13
$ 39250000 , 6000000.000000 ;Channel #-12
$ 33250000 , 6000000.000000 ;Channel #-11
$ 27250000 , 6000000.000000 ;Channel #-10
$ 21250000 , 6000000.000000 ;Channel #-9
$ 15250000 , 6000000.000000 ;Channel #-8
$ 9250000 , 6000000.000000 ;Channel #-7
$ 0.0000 , 6000000.000000 ;Channel #-6
$ 0.0000 , 6000000.000000 ;Channel #-5
$ 0.0000 , 6000000.000000 ;Channel #-4
$ 0.0000 , 6000000.000000 ;Channel #-3
$ 0.0000 , 6000000.000000 ;Channel #-2
$ 0.0000 , 6000000.000000 ;Channel #-1
$ 45500000.0000 , 6000000.000000 ;Channel #0
```

```
.
.
.
```

Step 3.
Installing the
CTNTSCM.PLN
file

1. Copy the edited CTNTSCM.PLN file to a floppy disk.
2. Insert the disk into the analyzer.
3. Press the **File** key, then follow [Step 1. Copy the CTNTSCM.PLN file onto a floppy disk on page 2-24](#), but use the [-A-] drive as your “from” directory (**Dir From** key), and the [-C-] drive as your “to” directory (**Dir To** key).

The channel plan is now installed. Cycle the power on the analyzer.

Press **MEASURE, Setup, Plan** and select the appropriate new channel plan.

3

If You Have a Problem

What You Will Find in This Chapter

The purpose of this chapter is to help you if you have a problem. If the problem is related to the spectrum analyzer mode of operation, consult the documentation for the analyzer.

This chapter is divided into the following sections:

- Problems that are indicated by error messages that appear on the analyzer display.
- Other types of problems (problems that are not indicated by error messages).
- How to contact Agilent Technologies.

Error Messages

A Parameter has changed. Results may be invalid (press ESC to clear).

This message indicates that a change was made (such as to the span parameter) that may affect the validity of the measurement results. To clear this message, press the **Esc** key.

To solve the problem:

- Return the changed parameter to the original value, or press **C/N Ratio** (for example), to restart the measurement.

Option Not Installed

This message appears when the internal preamplifier is not installed. This is normal for instruments without a preamplifier.

TV Standard not Supported, Set to Previous Setting

This message appears only if TV Trigger (Option B7B) is installed. It appears when trying to set the TV standard under the **Trig** key to a standard other than one of the following when a CATV measurement is active:

- NTSC-M
- NTSC-JAPAN
- PAL-M
- PAL-B/D/G/H/I

If this occurs, then the TV standard under the **Trig** key will be reset to its previous setting.

TV Standard Under Standard is Set to the one Under Setup

This message appears only if TV Trigger (Option B7B) is installed. It appears at the beginning of the measurement when the TV standard under the **Trig** key and TV standard under the **MEASURE** key are not the same. When a CATV measurement is started, whatever standard is set under the **Trig** menu is changed to match the standard that was set under **MEASURE, CATV, Setup, TVSTD**. This message is shown to let you know that this change has been made.

If the Test Results Are Not What You Expected

If the test results are not what you expected, it could be because of one of the following:

CAUTION

Do not exceed the specified power input limit for the analyzer.

- The input signal was not connected.
 - Ensure that the signal is present at the analyzer input.
- The input signal is too low to be measured.
 - If the input signal is too low, use a preamplifier to boost the input signal (ensure that the voltage and power of the input signal does not exceed the specified input limits for the analyzer). See [Chapter 7, “Specifications and Test Aids,”](#) for more information about the minimum carrier level needed.

How to Contact Agilent Technologies

In the unlikely event that something goes wrong with your analyzer, refer to the documentation that came with the analyzer about returning the component for service. If you need to contact Agilent Technologies for a problem with the ESA Option 227 Cable TV Measurement Personality, you can call your nearest Agilent Technologies Sales and Service office listed on “Agilent Technologies Sales and Service Offices” on page 8-6.

What You Will Find in This Chapter

This chapter contains the channel measurements menu map.

Channel Measurements Menu Map

The following menu map shows all channel measurement mode keys and how they are accessed. The words within the ovals designate the front panel key that must be pressed to access the given menu.

Figure 4-1 Channel Measurements Main Menu

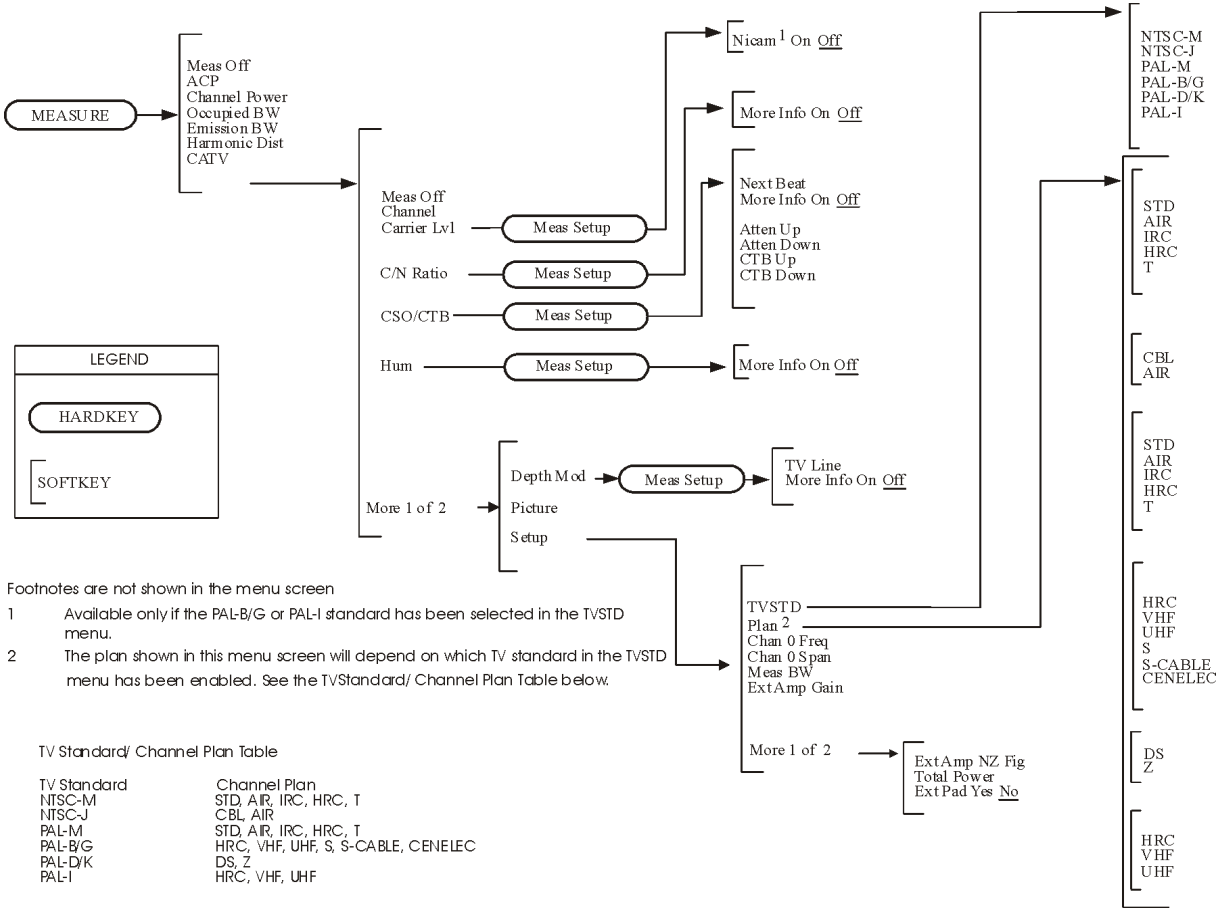

5 **SCPI Commands**

SCPI Commands

This chapter contains the SCPI commands used with the ESA Option 227 Cable TV Measurement Personality.

NOTE

Some familiarity with the SCPI language is necessary to run these commands properly. A copy of all four volumes of the SCPI Standard can be obtained through the SCPI Consortium. For more information, visit their web site at www.scpiconsortium.org/scpistandard.htm.

[Table 5-1 on page 5-3](#) contains the SCPI commands used with the Cable TV Measurement Personality (ESA Option 227). A French brace notation { } is used in some cases to show the allowed set of values. The square brace notation [] is used for default SCPI nodes.

Before any measurement is performed, it is *important* to use the SETup command to set the desired TV standard and other necessary configuration parameters, as well as the CHANnel command to set the desired channel.

NOTE

An additional way to set the TV standard is provided if TV Trigger (Option B7B) is installed. This method is by pressing keys Trig, TV Trig Setup, Standard. The two methods of setting the TV standard work independently of each other. However, when a CATV measurement is started, whatever standard was set using the TRIG command is changed to match the standard that was set using the SETup command.. Therefore, it is important that the SETup command is used to set the TV standard before starting CATV measurements.

NOTE

TV standard information is stored in nonvolatile analyzer memory. The analyzer will retain the information even when the power has been turned off. You do not need to set the TV standard every time the instrument is powered up.

To set the TV standard PAL-I using the SETup command, type:

```
SETup: TVStandard IPAL;
```

To set the channel plan to the first channel plan of the desired TV standard in the CTNTSCM.PLN (TV standard NTSC-M for instance) and channel number to 3, you would type:

```
CHANnel:MNTSc:0;
```

```
CHANnel:NUMBER:3;
```

For each measurement there is a MEASure group of commands that allows the user to control the measurement process in varying degrees. MEASure:<MEAS>? (where <MEAS> is the SCPI command for the desired measurement) performs the complete process where the analyzer is configured, a measurement is performed and all the results the measurement produces are returned.

When more control of the measurement is required, combining the CONFigure:<MEAS>? and READ:<MEAS>? commands is equivalent to the MEASure:<MEAS>? command, but with more flexibility. The analyzer configuration is performed with the CONFigure:<MEAS>? command, and the READ:<MEAS>? command runs the measurement and returns the requested value.

Furthermore, the same effects of the READ:<MEAS>? command can be obtained by combining the INITiate:[IMMEDIATE] and FETCh:<MEAS>? commands. INITiate:[IMMEDIATE] takes care of the data acquisition while FETCh:<MEAS>? functions on a single set of acquired data. An example of equivalent of command sets for the Composite Second Order (CSO)/Composite Triple Beat (CTB) measurement is presented in [Table 5-2 on page 5-9](#).

NOTE

It is important to make sure that the SCPI commands allow enough time for the measurement to produce a result, otherwise you might experience time-out errors. Also, the [SENse] set of commands should be performed only when their corresponding measurements are running.

Table 5-1 SCPI Commands

Command	Description
:CHANnel:BPAL{0 to 5 }	Set/Query the PAL-B/G Channel Plan (6 plan Maximum)
:CHANnel:DPAL{0 to 1 }	Set/Query the PAL-D/K Channel Plan (2 Plan Maximum)
:CHANnel:IPAL{0 to 2 }	Set/Query the PAL-I Channel Plan (3 Plan Maximum)
:CHANnel:JNTSc{0 to 1 }	Set/Query the NTSC-J Channel Plan (2 Plan Maximum)
:CHANnel:MNTSc{0 to 4 }	Set/Query the NTSC-M Channel Plan (5 Plan Maximum)

Table 5-1 SCPI Commands

Command	Description
:CHANnel:MPAL{0 to 4}	Set/Query the PAL-M Channel Plan (5 Plan Maximum)
:CHANnel:NUMBer	Set/Query the Channel
:CHANnel:UFRequency	Set/Query the User 0 Frequency
:CHANnel:USPan	Set/Query the User 0 Span
:CONFigure:CARLvl	Configure Carrier Level Measurement
:CONFigure:CARNois	Configure Carrier to Noise Measurement
:CONFigure:CSOCTB	Configure CSO/CTB Measurement
:CONFigure:DMODulation	Configure Depth of Modulation Measurement
:CONFigure:HUM	Configure Hum Measurement
:CONFigure:TPOWer	Configure Total Power Measurement
:FETCh:CARLvl?	Return Carrier Level ^a , Aural Level, Aural 2 Level, Carrier Frequency, Aural, Frequency, and Aural 2 Frequency ^b
:FETCh:CARLvl:AUR?	Return Aural Level
:FETCh:CARLvl:AURFREQ?	Return Aural Frequency
:FETCh:CARLvl:AUURFREQ?	Return Aural 2 Frequency ^b
:FETCh:CARLvl:AURS?	Return Aural 2 Level
:FETCh:CARLvl:CAR?	Return Carrier Level ^a
:FETCh:CARLvl:CARFREQ?	Return Carrier Frequency
:FETCh:CARNois?	Return Carrier to Noise Ratio
:FETCh:CARNois:ANFCorrection?	Return External Amp Noise Correction Factor
:FETCh:CARNois:BWCORrection?	Return Measurement Bandwidth Correction
:FETCh:CARNois:CAR?	Return Carrier Level ^a
:FETCh:CARNois:CNR?	Return Carrier to Noise Ratio
:FETCh:CARNois:LDCorrect?	Return Log Detection Correction Factor
:FETCh:CARNois:MEASBW?	Return Measurement Bandwidth
:FETCh:CARNois:NCORrected?	Return Corrected Noise Level ^a
:FETCh:CARNois:NEPBW?	Return Noise Equivalent Power Bandwidth
:FETCh:CARNois:NNNCorr?	Return Near Noise Correction Factor

Table 5-1 SCPI Commands

Command	Description
:FETCh:CARNois:TPOWer?	Return Total Power ^a
:FETCh:CARNois:UCNoise?	Return Uncorrected Noise Level at Marker ^a
:FETCh:CSOCTB?	Return Beat Level and Offset Frequency
:FETCh:CSOCTB:CBEAt?	Return Beat Level
:FETCh:CSOCTB:COFFset?	Return Offset Frequency
:FETCh:DModulation?	Measure Depth of Modulation
:FETCh:HUM?	Return Hum Percent ^c , Hum dB ^d , Marker Frequency (FFT), Marker Percent ^c (FFT) and Marker dB ^d (FFT)
:FETCh:HUM:HUMJapan?	Return Hum dB ^d
:FETCh:HUM:HUMpercent?	Return Hum Percent ^c
:FETCh:HUM:MKRDb?	Return Marker dB ^d (FFT)
:FETCh:HUM:MKRFreq?	Return Marker Frequency (FFT)
:FETCh:HUM:MKRPercent?	Return Marker Percent ^c (FFT)
:FETCh:TPOWer?	Return Total Power ^a
:FETCh:TPOWer:POWer?	Return Total Power ^a
:MEASure:CARLvl?	Measure Carrier Level ^a , Aural Level, Aural 2 Level, Carrier Frequency, Aural Frequency and Aural 2 Frequency ^b
:MEASure:CARLvl:AUR?	Measure Aural Level
:MEASure:CARLvl:AURFREQ?	Measure Aural Frequency
:MEASure:CARLvl:AURFREQS?	Measure Aural 2 Frequency ^b
:MEASure:CARLvl:AURS?	Measure Aural 2 Level
:MEASure:CARLvl:CAR?	Measure Carrier Level ^a
:MEASure:CARLvl:CARFREQ?	Measure Carrier Frequency
:MEASure:CARNois?	Measure Carrier to Noise Ratio
:MEASure:CARNois:ANFCorrection?	Measure External Amp Noise Correction Factor
:MEASure:CARNois:BWCorrection?	Measure Measurement Bandwidth Correction
:MEASure:CARNois:CAR?	Measure Carrier Level ^a
:MEASure:CARNois:CNR?	Measure Carrier to Noise Ratio

Table 5-1 SCPI Commands

Command	Description
:MEASure:CARNois:LDCorrect?	Measure Log Detection Correction Factor
:MEASure:CARNois:MEASBW?	Measure Measurement Bandwidth
:MEASure:CARNois:NCORrected?	Measure Corrected Noise Level ^a
:MEASure:CARNois:NEPBW?	Measure Noise Equivalent Power Bandwidth
:MEASure:CARNois:NNNCorr?	Measure Near Noise Correction Factor
:MEASure:CARNois:TPOwer?	Measure Total Power ^a
:MEASure:CARNois:UCNoise?	Measure Uncorrected Noise Level at Marker ^a
:MEASure:CSOCTB?	Measure Beat Level and Offset Frequency
:MEASure:CSOCTB:CBEAt?	Measure Beat Level
:MEASure:CSOCTB:COFFset?	Measure Offset Frequency
:MEASure:DMODulation?	Measure Depth of Modulation
:MEASure:HUM?	Measure Hum Percent ^c , Hum dB ^d , Marker Frequency (FFT), Marker Percent ^c (FFT) and Marker dB ^d (FFT)
:MEASure:HUM:HUMJapan?	Measure Hum dB ^d
:MEASure:HUM:HUMpercent?	Measure Hum Percent ^c
:MEASure:HUM:MKRDb?	Measure Marker dB ^d (FFT)
:MEASure:HUM:MKRFreq?	Measure Marker Frequency (FFT)
:MEASure:HUM:MKRPercent?	Measure Marker Percent ^c (FFT)
:MEASure:TPOwer?	Measure Total Power ^a
:MEASure:TPOwer:POwer?	Measure Total Power ^a
:READ:CARLvl?	Measure Carrier Level ^a , Aural Level, Aural 2 Level, Carrier Frequency, Aural Frequency and Aural 2 Frequency ^b
:READ:CARLvl:AUR?	Measure Aural Level
:READ:CARLvl:AURFREQ?	Measure Aural Frequency
:READ:CARLvl:AURFREQS?	Measure Aural 2 Frequency ^b
:READ:CARLvl:AURS?	Measure Aural 2 Level
:READ:CARLvl:CAR?	Measure Carrier Level ^a
:READ:CARLvl:CARFREQ?	Measure Carrier Frequency

Table 5-1 SCPI Commands

Command	Description
:READ:CARNois?	Measure Carrier to Noise Ratio
:READ:CARNois:ANFCorrection?	Measure External Amp Noise Correction Factor
:READ:CARNois:BWCorrection?	Measure Measurement Bandwidth Correction
:READ:CARNois:CAR?	Measure Carrier Level ^a
:READ:CARNois:CNR?	Measure Carrier to Noise Ratio
:READ:CARNois:LDCorrect?	Measure Log Detection Correction Factor
:READ:CARNois:MEASBW?	Measure Measurement Bandwidth
:READ:CARNois:NCORrected?	Measure Corrected Noise Level ^a
:READ:CARNois:NEPBW?	Measure Noise Equivalent Power Bandwidth
:READ:CARNois:NNNCorr?	Measure Near Noise Correction Factor
:READ:CARNois:TPOWer?	Measure Total Power ^a
:READ:CARNois:UCNoise?	Measure Uncorrected Noise Level at Marker ^a
:READ:CSOCTB?	Measure Beat Level and Offset Frequency
:READ:CSOCTB:CBEAt?	Measure Beat Level
:READ:CSOCTB:COFFset?	Measure Offset Frequency
:READ:DMODulation?	Measure of Modulation
:READ:HUM?	Measure Hum Percent ^c , Hum dB ^d , Marker Frequency (FFT), Marker Percent ^c (FFT) and Marker dB ^d (FFT)
:READ:HUM:HUMJapan?	Measure Hum dB ^d
:READ:HUM:HUMpercent?	Measure Hum Percent ^c
:READ:HUM:MKRDb?	Measure Marker dB ^d (FFT)
:READ:HUM:MKRFreq?	Measure Marker Frequency (FFT)
:READ:HUM:MKRPercent?	Measure Marker Percent ^c (FFT)
:READ:TPOWer?	Measure Total Power ^a
:READ:TPOWer:POWer?	Measure Total Power ^a
[:SENSe]:CARLvl:NICam{ON/OFF}	Set NICAM Carrier for Carrier Level and Frequency Measurement
[:SENSe]:CARNois:MINFo {ON/OFF}	Set/Query More info for Carrier to Noise Measurement
[:SENSe]:CSOCTB:ATTDown	Decrease Attenuation by 5 dB

Table 5-1 SCPI Commands

Command	Description
[[:SENSe]:CSOCTB:ATTUp	Increase Attenuation by 5 dB
[[:SENSe]:CSOCTB:CTBDown	Set marker to next CTB below carrier
[[:SENSe]:CSOCTB:CTBUp	Set marker to next CTB above carrier
[[:SENSe]:CSOCTB:MINFo {ON/OFF}	Set/Query More info for CSO/CTB Measurement
[[:SENSe]:CSOCTB:NEXTbeat	Set marker to next beat
[[:SENSe]:DMODulation:MINFo {ON/OFF}	Set/Query More info for Depth of Mod. Measurement
[[:SENSe]:DMODulation:TVLine {1 to 525} ^e	Set/Query TV Line number
[[:SENSe]:HUM:MINFo {ON/OFF}	Set/Query More info for Hum Measurement
:SETup:EXTGain	Set/Query External Amp Gain ^f
:SETup:EXTNZ	Set/Query Amp Noise Figure ^f
:SETup:MEASbw	Set/Query Measurement Bandwidth for Carrier to Noise
:SETup:EXTPad {ON/OFF}	Set/Query the External Pad Feature
:SETup:TVStandard {MNTSc/JNTSc/MPAL/BPAL/DPAL/IPAL}	Set/Query the TV Standard

- a. Result displayed in dBm unit.
- b. Result resets to zero for NICAM carrier
- c. Initialized to zero NTSC-J
- d. Initialized to zero except NTSC-J
- e. Range changes to {1 to 625} for PAL-B/G, PAL-D/K, PAL-I
- f. See the notes on [page 7](#) in Chapter 7 for proper usage.

Table 5-2 Examples of SCPI Usage in the CSOCTB Measurement

Command	Result
MEASure:CSOCTB?;	Returns beat level and offset frequency results.
CONFigure:CSOCTB; INITiate; FETCh:CSOCTB?; CSOCTB:NEXtbeat; INITiate; FETCh:CSOCTB?;	Returns beat level and offset frequency results. Returns next beat level and offset frequency results.
CONFigure:CSOCTB; READ:CSOCTB:COFFset?;	Returns offset frequency results.
CONFigure:CSOCTB; INITiate; FETCh:CSOCTB:COFFset?;	Returns offset frequency results.

What You Will Find in This Chapter

This chapter describes the cable TV tests found in the Channel and System modes of operation. The test descriptions are as follows:

- Visual Carrier Level and Visual-to-Aural Level and Frequency Difference Test Description
- Carrier-to-Noise Test Description
- Composite Second Order (CSO) Test Description
- Composite Triple Beat (CTB) Test Description
- Hum Test Description
- Depth of Modulation Test Description

Visual Carrier Level and Visual-to-Aural Level and Frequency Difference Test Description

The visual carrier level test measures the peaks and frequency of the visual carrier, as well as the visual-to-aural level and frequency difference.

To perform the visual carrier level and visual-to-aural level difference test, the analyzer does the following:

1. Changes the resolution bandwidth, video bandwidth, and sweep time of the analyzer to capture the levels accurately, and it turns on the frequency counter as well.
2. Measures the visual amplitude level and aural carrier difference.

Figure 6-1 on page 6-3 shows the analyzer measuring the visual carrier level and aural carrier difference.

NOTE

Figure 6-2 on page 6-4 and Figure 6-3 on page 6-4 show the analyzer measuring the PAL-B/G visual and sound carriers with Nicam Off and Nicam On.

Figure 6-1 Measuring the Visual Level and Aural Carrier Difference (NTSC-M)

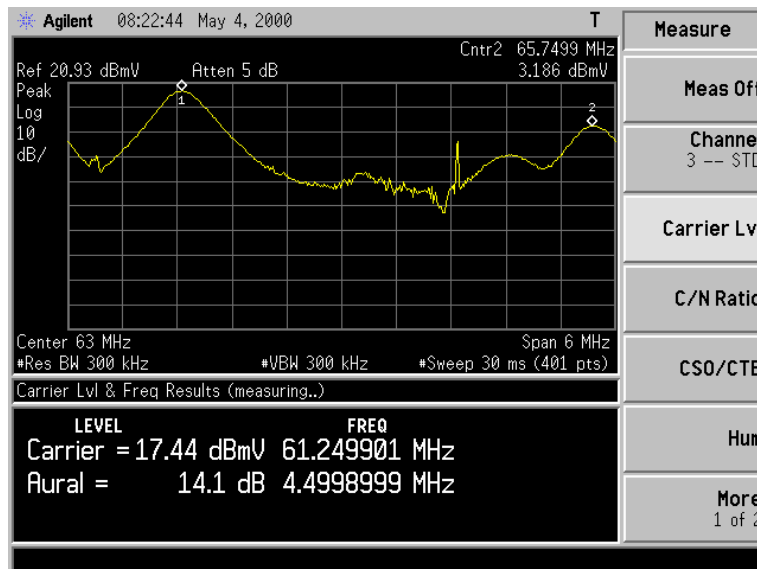

Figure 6-2 Measuring the Visual Level and Aural Carrier Difference (PAL-B/G with Nicam Off)

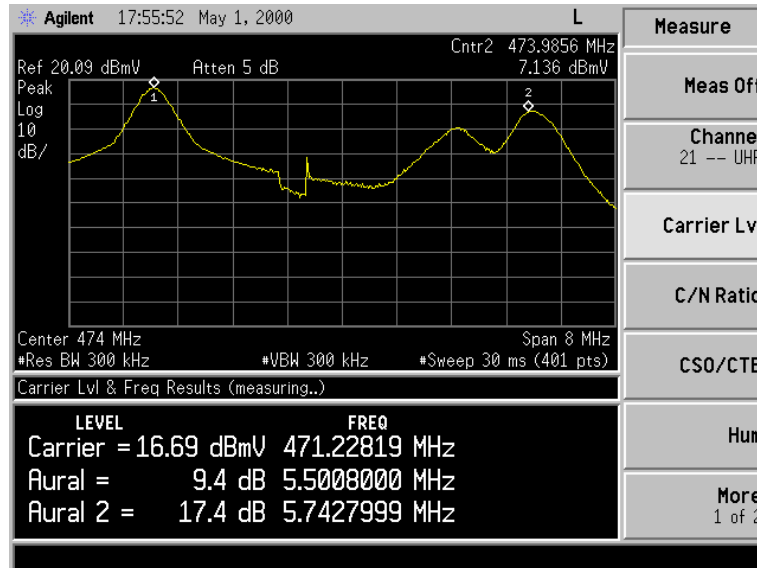
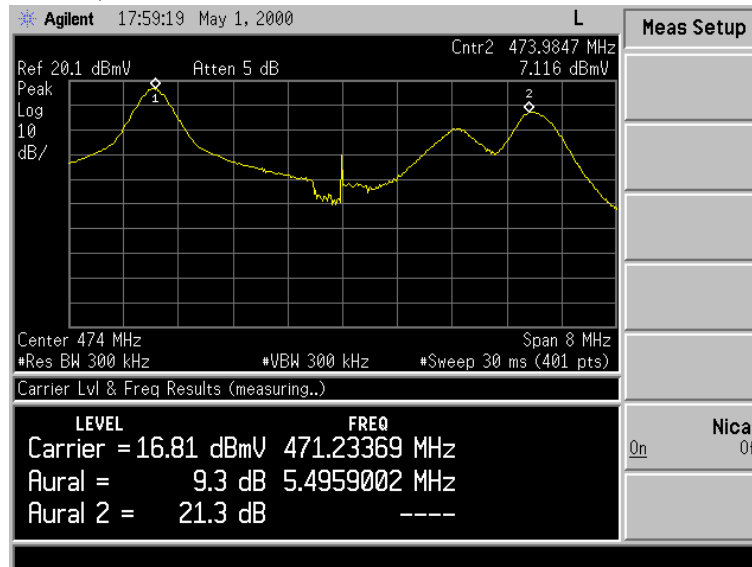

Figure 6-3 Measuring the Visual Level and Aural Carrier Difference (PAL-B/G with Nicam On)



The test runs continually, and test results are updated after each test cycle (after each sweep). To exit the test press **Meas Off**.

With **Nicam On Off** selected (On), a true RMS measurement is made of the NICAM band.

Visual Carrier Level and Visual-to-Aural Level and Frequency Difference Test Description

The aural carrier must be within 4.1 MHz to 4.9 MHz of the visual carrier to be detected as the aural carrier. If the aural carrier cannot be detected, the visual-to-aural frequency difference measurement cannot be done, and a notice will be displayed.

NOTE

The aural carrier range must be within 5.0 to 6.5 MHz for PAL-B/G, PAL-D/K and PAL-I.

NOTE

Due to the nature of the NICAM signal, detecting and measuring its center frequency is not possible.

Carrier-to-Noise Ratio Test Description

The result of the carrier-to-noise measurement is the ratio of the peak visual carrier level (modulated or unmodulated) to the noise measured in one of the manners described below (see [Figure 6-4 on page 6-7](#)). This ratio is normalized to a 4 MHz noise-power bandwidth.

NOTE

For PAL-B/G, PAL-D/K and PAL-I the ratio is normalized to 5 MHz noise-power bandwidth. See [Figure 6-5 on page 6-8](#).

This bandwidth can be changed by the user.

There are two methods of measuring carrier-to-noise:

1. In-between channels
2. Disable modulation and measure over measurement range

In-Between Channels

In the first method, the peak carrier level is measured first, then it continuously updates and reports the carrier-to-noise ratio for the marker position. The marker can be moved as desired and the result is updated to reflect the most current test result. At the end of each sweep, the marker does a local minimum search as well as a local trace average.

Before executing the test, the analyzer initially measures the total power of the entire cable system. This is done to set the attenuator to avoid overload of the input mixer and noise floor lift due to internally generated distortion. The analyzer then measures its own noise figure and uses this for calculating the final carrier-to-noise value. The analyzer input attenuation is set to both prevent input mixer compression and minimize the noise level of the analyzer.

Initially, the marker is placed at the lower channel boundary. This provides an indication of the distribution system noise level without having to remove modulation. The minimum noise level is measured and compared with the noise level of the analyzer. If the difference between the minimum noise level and the noise floor is less than 10 dB, and the minimum noise value cannot be measured directly, it is calculated using the following formula:

$$\text{System Noise} = 10\text{LOG}[10^{\text{DN}} - 10^{\text{AN}}]$$

where:

DN = displayed noise ÷ 10

AN = analyzer noise ÷ 10

To find the ratio of the visual carrier level to the noise level, the minimum noise level value is subtracted from the carrier peak level. The ratio is then normalized to a noise-power bandwidth value selected by pressing **MEASURE, CATV, Setup, Meas BW**.

The message “See MORE INFO” is displayed if the system noise is within 3 dB of the analyzer noise. This can be the case when carrier-to-noise is greater than 50 dB, and carrier levels are less than 20 dBmV (80 dBμV). Refer to the graphs in the specifications section located in your spectrum analyzer calibration guide.

NOTE

External preamplifier usage can be enhanced by entering amplifier gain and noise figure values in the setup menu. By selecting an external preamplifier in the setup menu, errors caused by the preamplifier can be accounted for in the carrier-to-noise calculation. See the notes on [page 7](#) in Chapter 7 for proper usage.

When the internal preamplifier automatically turns on, its gain and noise figure area is automatically accounted for and requires no operator attention.

Averaging minimizes the measurement-to-measurement variation of the system noise determination. Press **BW/Avg, Average On. Average Type** type should be set to **Video** for this measurement.

Figure 6-4 Carrier-to-Noise Measurement (NTSC-M)

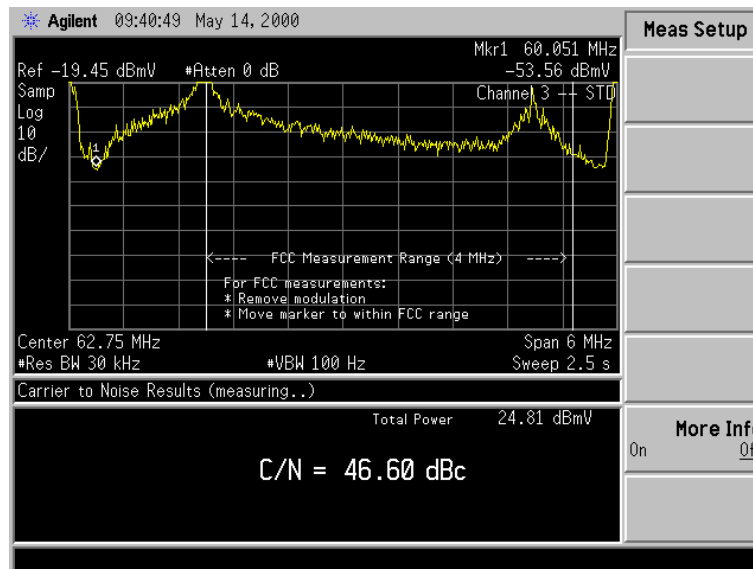

Test Descriptions
Carrier-to-Noise Ratio Test Description

Figure 6-5 Carrier-to-Noise Measurement (NTSC-M)

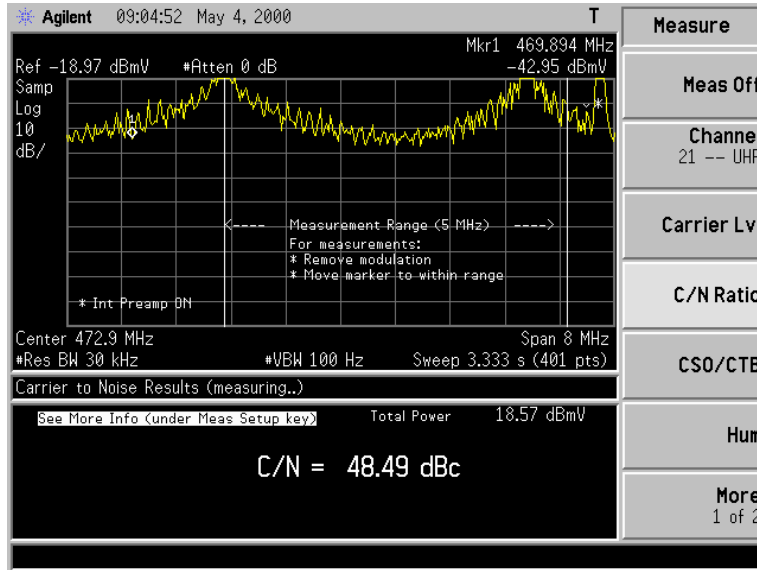

Pressing the **More Info** softkey shows the raw data and all corrections used for this measurement. See [Figure 6-6 on page 6-8](#).

Figure 6-6 More Info Screen (NTSC-M)

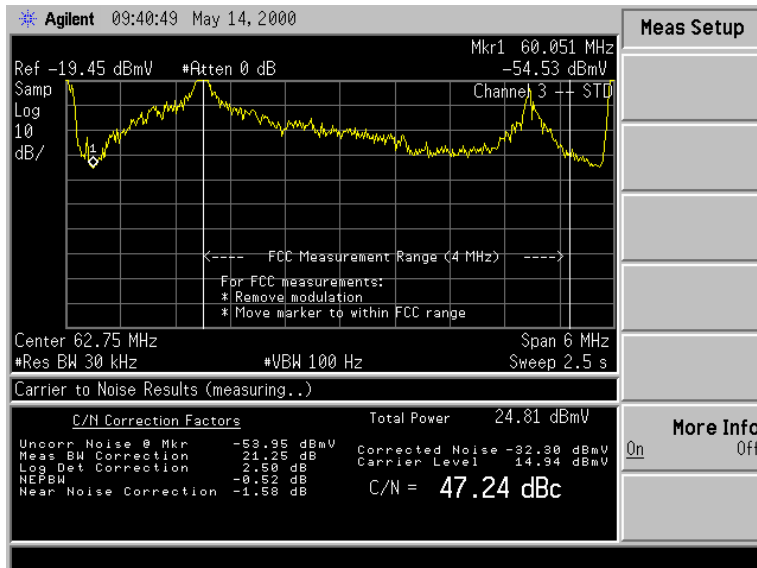

With the modulation on, the measurement range is limited to 55 dB. Use the following method of carrier and modulation off for >55 dB dynamic range.

Disable Carrier, Modulation and Measure over Measurement Range

The second method is an interfering measurement of carrier-to-noise in which the carrier and modulation are removed. The marker is positioned within the displayed measurement range. Averaging can be selected to stabilize the noise measurement. For best results turn the modulator off.

Before returning to the main menu, the modulator must be turned on.

More Discussion about the Carrier-to-Noise Test

The carrier-to-noise test is very flexible and can handle a wide variety of testing conditions. It provides feedback messages to assist you in achieving the optimum test setup.

Like any cable TV active device, a spectrum analyzer has an ideal operating point which balances carrier-to-noise and carrier beats. When a spectrum analyzer is operating at its optimum point, it has its greatest testing dynamic range. However, to achieve acceptable results, it is not always necessary to operate the spectrum analyzer exactly at its optimum point. To achieve acceptable results, only two conditions are needed:

1. The total power at the analyzer input is below the overload level of the analyzer.
2. The noise floor being measured is equal to or greater than the noise floor of the analyzer. The attenuator switch point for C/N is +47 dBmV

Channel loading forces down the highest acceptable level of each individual channel carrier creating the need to preselect the channel of interest. This is necessary when the noise floor being measured is less than the analyzer noise floor and when the total input power is near overload. The only way to raise the noise floor without overloading the analyzer is to reduce channel loading through preselection.

When **C/N Ratio** is pressed the analyzer measures the total power at the input, the level of the channel to be measured, and the analyzer noise floor. Based on this information, it decides whether to turn on the internal preamp if this option is available, and what the analyzer attenuator setting should be. In addition, it alerts you when it thinks additional attention is needed. This is indicated by the presence of the message "See MORE INFO" in the lower part of the screen. This message occurs when the cable noise floor is within 3 dB of the analyzer noise floor. It is intended to alert the operator that the analyzer noise-near-noise correction is working. In addition, the message is presented in inverse video when the cable noise floor is within 2.2 dB of the analyzer noise. This indicates that the analyzer is correcting the result by more than 3 dB, and measurement uncertainty of the result is rising. It is intended that you raise the input level and preselect if necessary.

Test Descriptions

Carrier-to-Noise Ratio Test Description

In a flat system, once the optimum input power level is achieved, it does not need to be readjusted for each channel. All channels can be measured without further adjustments to the input level.

If the internal preamplifier option is available, it is controlled automatically. It is only turned on at levels low enough to prevent overload. When the internal preamplifier is turned on, a message to that effect is displayed on the screen.

See “Carrier-to-Noise Test” on page 2-11 for information on how to make a measurement. See the tables and figure on [page 6](#) and [page 7](#) in Chapter 7 for measurement range based on carrier level, as well as measurement accuracy based on measurement result.

Composite Second Order (CSO) Test Description

In the CSO measurement, the analyzer measures the total cable TV system power and adjusts its input attenuation for optimum performance (refer to the graphs in Chapter 7, “Specifications and Test Aids.”)

Distortion near noise corrections are used to more accurately measure distortion products less than 10 dB above the analyzer noise.

The composite second order (CSO) test measures the relative level of second order intermodulation products that are offset from the carrier under test.

NOTE

The second order intermodulation products offset from the carrier under test vary from TV standard to TV standard. See [Table 6-1](#) below.

Table 6-1

Beats Offset

TV Standard	Offset
PAL-M	-1.25 MHz, -0.75 MHz, +0.75 MHz and +1.25 MHz
NTSC-J	-1.25 MHz, +1.25 MHz, +2.0 MHz, +2.75 MHz, +3.25 MHz and +4.0 MHz
NTSC-M	-1.25 MHz, -0.75 MHz, +0.75 MHz and +1.25 MHz
PAL-B/G (7 MHz)	+0.75 MHz, +4.5 MHz and +5.25 MHz
PAL-B/G (8 MHz), PAL-D/K, PAL-I	+0.75 MHz, +5.5 MHz and +6.25 MHz

The trace is a time averaged display appropriate for measuring beats. The marker does a local peak search to assure it is measuring the peak of the beat. See [Figure 6-7 on page 6-12](#).

NOTE

For NTSC-J, please refer to [Figure 6-8 on page 6-12](#). For PAL-B/G, PAL-D/K and PAL-I see [Figure 6-9 on page 6-13](#).

Figure 6-7 Determining the Level of the Beat Product and Offset Frequency (NTSC-M)

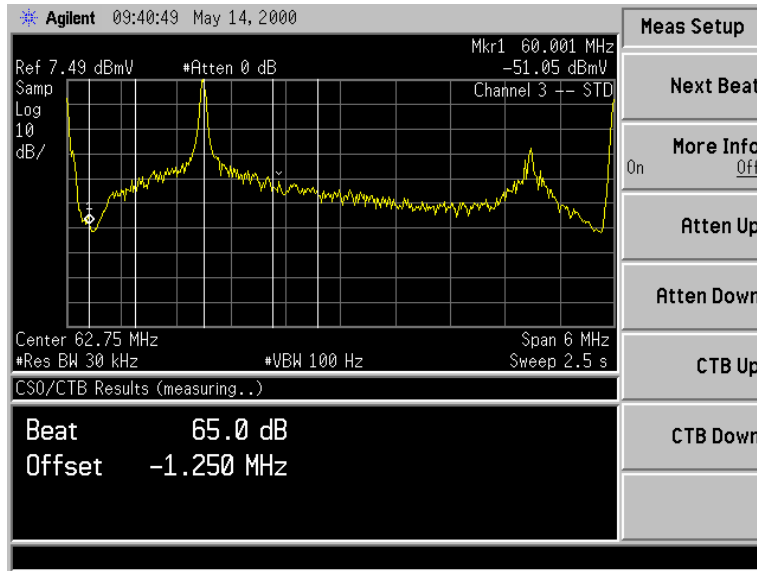

Figure 6-8 Determining the Level of the Beat Product and Offset Frequency (NTSC-J)

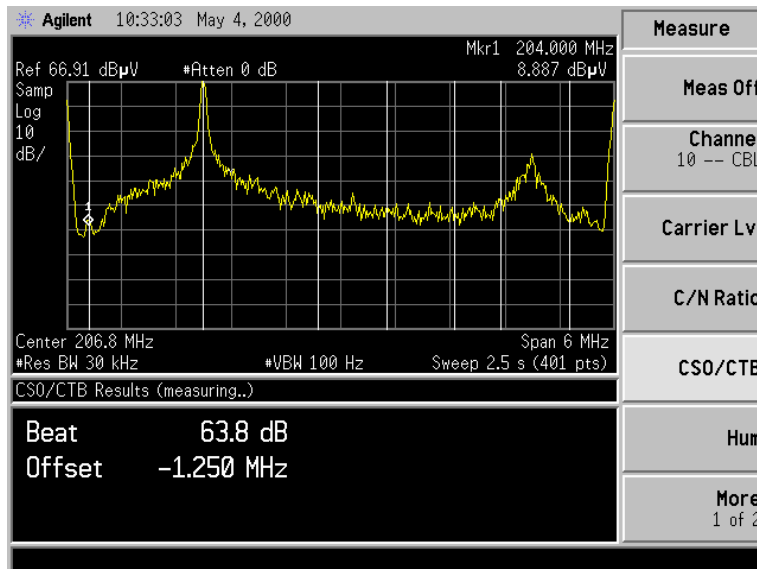
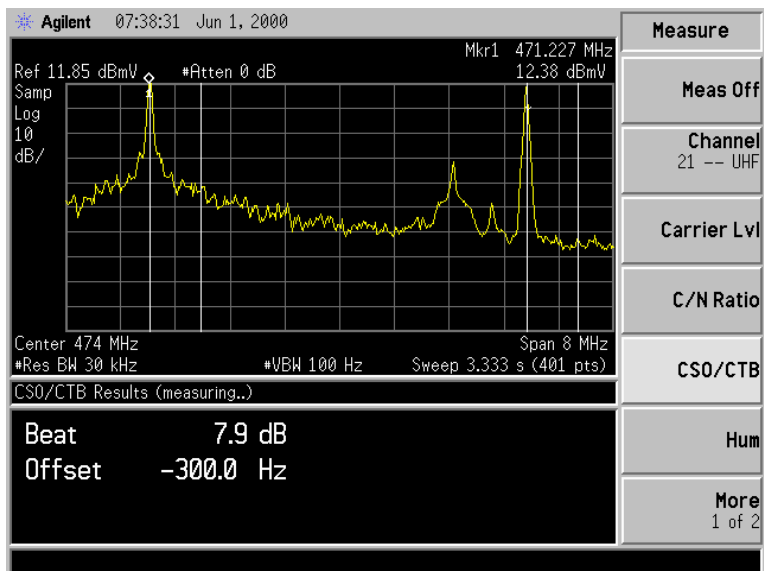

Figure 6-9 Determining the Level of the Beat Product and Offset Frequency (PAL-B/G)



Composite Triple Beat (CTB) Test Description

In the CTB measurement, the analyzer measures the total cable TV system power and adjusts its input attenuation for optimum performance (refer to the graphs in [Figure 7-1 on page 7-7](#)).

Distortion near the noise correction is used to more accurately measure distortion products less than 10 dB above the analyzer noise.

The CTB appears directly under the visual carrier. Therefore, turning the carrier off during the channel CSO/CTB test is the only method of testing the CTB of each channel.

The marker does a local peak search to assure it is measuring the peak of the time averaged beat.

The Beat Level is Measured To accurately determine beat amplitude, the beat level is measured and compared with the level of the analyzer noise. If the difference between the beat level and the analyzer noise is less than 10 dB, the beat value cannot be measured directly; instead, it is calculated by using the formula:

$$\text{Beat Level} = 10\text{LOG}[10^{\text{BP}} - 10^{\text{NL}}]$$

where:

$$\text{BP} = \text{Beat product} \div 10$$

$$\text{NL} = \text{Analyzer noise level} \div 10$$

With this method of measuring CTB, a preamplifier is not generally needed for accurate testing.

The Beat Level is Subtracted from the Visual Carrier Peak Level To find the value for CTB, the beat level is subtracted from the visual carrier peak level.

**More Discussion
about the
CSO/CTB Tests**

The carrier-to-beats test is very flexible and can handle a wide variety of testing conditions. It provides feedback messages to assist you in achieving the optimum test setup.

Like any cable TV active device, a spectrum analyzer has an ideal operating point which balances C/N and C/Beats. When a spectrum analyzer is operating at its optimum point, it has its greatest testing dynamic range. However, to achieve acceptable results, it is not always necessary to operate the spectrum analyzer exactly at its optimum point. To achieve acceptable results, only 2 conditions are needed:

1. The total power at the analyzer input is below the overload level of the analyzer.
2. The beat being measured is equal to or greater than 3 dB above the noise floor of the analyzer.

Channel loading forces down the highest acceptable level of each individual channel carrier creating the need to preselect the channel of interest. This is necessary when the cable system noise floor is less than the analyzer noise floor and when the total input power is near overload. The only way to raise the noise floor without overloading the analyzer is to reduce channel loading through preselection.

When **CSO/CTB** is pressed, the analyzer measures the total power at the input, the level of the channel to be measured, and the analyzer noise floor. Based on this information, it decides what the analyzer attenuator should be set to.

Once the optimum input power level is achieved, it does not need to be readjusted for each channel. All channels can be measured without further adjustments to the input level.

Hum Test Description

The hum test measures the percentage of amplitude modulation for low frequency disturbances (hum) by measuring the peak-to-peak variation for total hum. Using “more info” under the measure setup, the Fast Fourier Transform (FFT) is used to display the low frequency spectrum around the carrier. This information can be used to identify the source of hum.

Total hum is measured by reading the peak-to-peak variation in the visual signal level caused by low frequency disturbances (hum or repetitive transients).

NOTE

The hum test automatically configures the analyzer for measuring with or without video modulation on the carrier. For NTSC-M, NTSC-J, and PAL-M this is necessary. This is because analyzer settings used to conform to NCTA recommended practices cannot be used when video modulation is present.

Other analyzer settings can be used to compensate for the presence of video modulation, then the measurement can be made.

When video modulation is on, the video bandwidth is set to 1 MHz to allow the analyzer to measure only the values of the sync tips. When the video bandwidth is set to 1 MHz, significant noise is also present. This noise is digitally minimized, then several peak-to-peak measurements are taken and averaged. Using the average of these measurements gives the best consistency with visual oscilloscope measurements. However, the effects of noise cannot be completely eliminated and the results reported have slightly more uncertainty (usually less than 1 percent larger) than when video modulation is off. The reverse, however, is not true. That is, when adding modulation to a carrier wave signal, results will increase, not decrease. For NTSC-M, NTSC-J and PAL-M, if the results are less than 3 percent with modulation on, then section 76.605(a)(10) of the FCC regulations is satisfied. If a channel does exceed 3 percent, it may still pass by testing again without video modulation.

When video modulation is not present, a setting of zero span with a sweep time of 5 ms/div acts as a signal level meter and oscilloscope display. With these settings for NTSC-M, NTSC-J, and PAL-M formats, the analyzer conforms to the conditions set forth in the NCTA recommended practices. A video bandwidth of 1 kHz functions as a 1 kHz low pass filter. Several peak-to-peak measurements are taken, then the average measurement is reported.

Figure 6-11 HUM, More Information (NTSC-M)

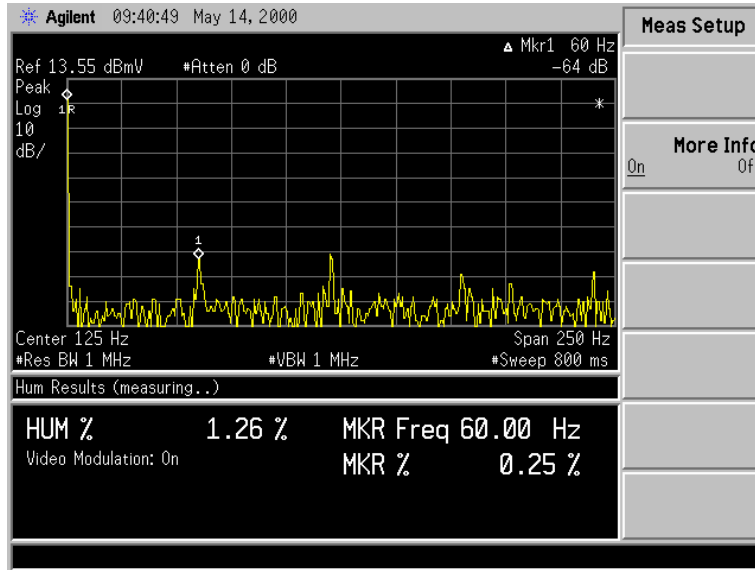
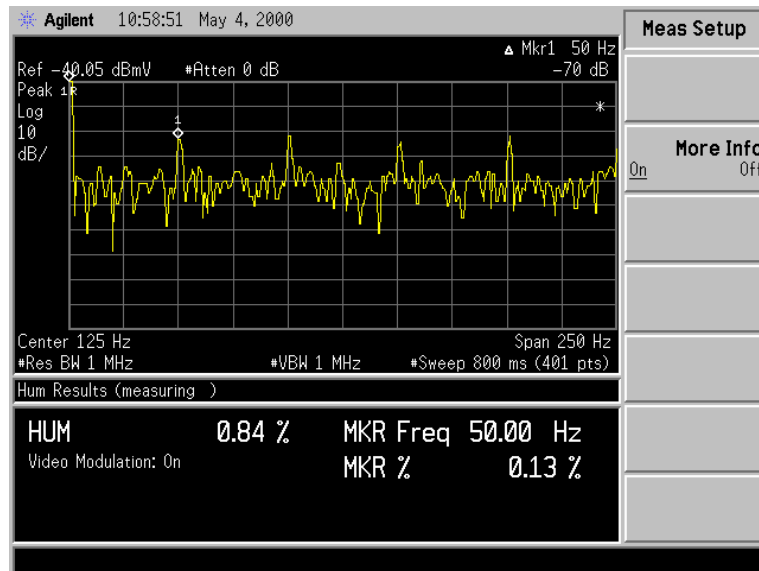

Figure 6-12 HUM, More Information (PAL-B/G)



Depth of Modulation Test Description

The depth of modulation test measures the percentage (50 to 93 percent measurement range) of amplitude modulation(AM) on the visual carrier. The analyzer measures the horizontal synchronization-pulse level and vertical interval test signal (VITS) white level from which it calculates the percentage of AM.

NOTE

The visual carrier AM modulation depth test may not be valid for scrambled channel signals depending on the method used to scramble the signals. So, when testing a scrambled channel, you may want to momentarily turn off scramble for the channel while the channel is being tested for AM modulation depth.

To perform the depth of modulation measurement, the analyzer does the following:

1. Changes the center frequency and reference level of the analyzer.
2. Changes the amplitude scale and span of the analyzer.
3. Measures the minimum level and the maximum level and calculates the percentage of AM modulation depth.

Changes the center frequency and reference level of the analyzer

The visual carrier is centered on the analyzer screen and a 1 MHz resolution bandwidth is used to capture the entire modulation signal. For better accuracy , the reference level of the analyzer is changed to the level the visual carrier.

Changes the amplitude scale and span of the analyzer

The amplitude scale is changed from logarithmic (dB) to linear (volts) and the span is set to 0 Hertz to demodulate the signal and display time domain characteristics.

Test Descriptions
Depth of Modulation Test Description

Measures the minimum level and the maximum level and calculates the percentage of AM modulation depth

The analyzer measures the minimum level and the maximum level. The minimum level corresponds to the vertical interval test signal (VITS) white level and the maximum level corresponds to the H-sync pulse. This ratio of minimum over maximum, subtracted from a value of 1 and multiplied by 100 gives the percentage of modulation:

$$\left[1 - \frac{\text{minimum}}{\text{maximum}} \right] \times 100 = \%AM$$

Figure 6-13 shows the analyzer measuring the minimum and maximum levels.

Figure 6-13 Measuring the Depth of Modulation (NTSC-M)

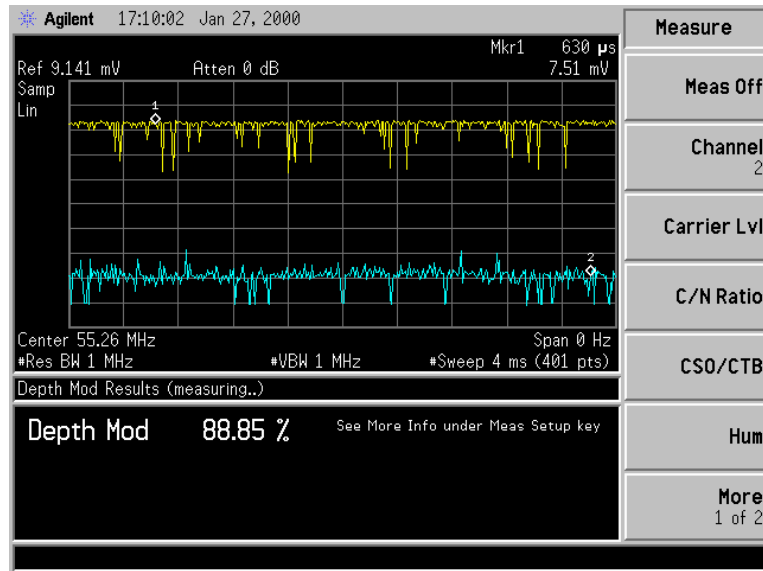

What You Will Find in This Chapter

This chapter outlines the specifications and characteristics of the ESA Option 227 Cable TV Measurement Personality with supported analyzers. In addition, test aids are provided. This chapter contains the following sections:

- Cable TV Measurement Specifications and Characteristics
- Channel Identification Plans

Cable TV Measurement Specifications and Characteristics

Specifications describe the warranted performance of the ESA Option 227 Cable TV Measurement Personality with supported analyzers over the temperature range of 0 °C to 55 °C.

Characteristics provide useful, but non-warranted, information in the form of typical, nominal, or approximate values for analyzer performance.

NOTE These measurement specifications and characteristics are based on specifications and characteristics given for the following Agilent Technologies ESA spectrum analyzers:

- E4401B
- E4402B
- E4404B
- E4405B
- E4407B

Input Configuration	
Select input conditions of spectrum analyzer.	
75 Ω Spectrum Analyzer	No selection required
50 Ω Spectrum Analyzer	Measurements converted to 75 Ω values
50 Ω Spectrum Analyzer Selections	
ESA-E Series Option 1D7 Ext Pad	Amplitude offset set to 5.8 dB
NO Ext Pad	Amplitude offset set to zero
Channel Selection	
Tune Configuration	Analyzer tunes to specified channels based upon selected tune configuration. Standard, Off-the Air, HRC, IRC, T (NTSC-M) CBL, Off-the Air (NTSC-J) Standard, Off-the Air, HRC, IRC, T (PAL-M) HRC, VHF, UHF, S, S-CABLE, CENELEC (PAL-B/G) DS, Z (PAL-D/K) HRC, VHF, UHF (PAL-I)

Specifications and Test Aids
Cable TV Measurement Specifications and Characteristics

Channel Range	NTSC-M: 1 to 158 NTSC-J: 1 to 63 (CBL), 1 to 62 (AIR) PAL-M: 1 to 158 PAL-B/G: 2 to 199 (HRC), 2 to 12 (VHF), 21 to 69 (UHF), 1 to 41 (S), 1 to 44 (S-CABLE), 1 to 42 (CENELEC) PAL-D/K: 1 to 68 (DS), 1 to 37 (Z) PAL-I: 1 to 199 (HRC), 1 to 13 (VHF), 21 to 69 (UHF)
Frequency Range	5 to 1600 MHz
Amplitude Range	+75 dBmV

Visual-Carrier Frequency	Visual-carrier frequency is counted
---------------------------------	-------------------------------------

Frequency Reference (Standard)	
Resolution	100 Hz
Accuracy	$\pm(7 \times 10^{-6} \times \text{carrier frequency} + 100 \text{ Hz})$
@55.25 MHz (Ch. 2)	$\pm 500 \text{ Hz}$
@325.25 MHz (Ch. 41)	$\pm 3.4 \text{ kHz}$
@643.25 MHz (Ch. 94)	$\pm 4.6 \text{ kHz}$

Visual-to-Aural Carrier Frequency Difference	Frequency difference between visual and aural carriers is counted
Difference Range	4.1 to 4.9 MHz (NTSC-M, NTSC-J, PAL-M) 5.0 to 6.5 MHz (PAL-B/G, PAL-D/K, PAL-I)
Resolution	100 Hz
Accuracy	$\pm 254 \text{ Hz}$

Specifications and Test Aids
Cable TV Measurement Specifications and Characteristics

Visual-Carrier Level	The peak amplitude of the visual carrier is measured to an absolute standard traceable to the National Institute of Standards and Technology.
Amplitude Range	-15 to +70 dBmV
Resolution	0.1 dB
Absolute Accuracy	±1.0 dB for S/N >30 dB
Relative Accuracy	±0.5 dB relative to adjacent channels in frequency
	±0.7 dB relative to all other channels

Visual-to-Aural Carrier Level Difference	The difference between peak amplitudes of the visual and aural carrier is measured.
Difference Range	0 to 25 dB
Resolution	0.1 dB
Accuracy	±0.5 dB for S/N >30 dB

Depth of Modulation (characteristic)	Percent AM is measured from horizontal sync tip to maximum video level; measurement requires a white-reference VITS and may not be valid for scrambled channels.
AM Range	50 to 93%
Resolution	0.1%
Accuracy	±2.0% for C/N >40 dB

Hum/Low-Frequency Disturbance	Power-line frequency and low-frequency disturbance measured on modulated or unmodulated carriers. May not be valid for scrambled channels.
AM Range	0.5 to 10%
Resolution	0.1%
Accuracy	±0.4% for hum ≤3% ±0.7% for hum ≤5% ±1.3% for hum ≤10%

Visual Carrier-to-Noise Ratio (C/N)*	The C/N is calculated from the visual-carrier peak level and the minimum noise level, normalized to 4 MHz [#] noise bandwidth.
---	---

Specifications and Test Aids
Cable TV Measurement Specifications and Characteristics

Optimum Input Range	See Graphs [†]
Maximum C/N Range	Input level dependent - See graphs [†]
C/N Resolution	0.1 dB
C/N Accuracy	Input level and measured C/N dependent ± 1.0 to ± 3.5 dB over optimum input range
*A preamplifier and preselector filter may be required to achieve specifications.	
[†] Optimum input range is determined at the time of measurement since a total input power measurement is first done to automatically set the attenuator.	
[#] For PAL-B/G, PAL-D/K and PAL-I the C/N is normalized to 5 MHz noise bandwidth.	
If the modulation or carrier is turned on and noise is measured within ± 2 MHz of the carrier, the maximum C/N range is 55 dB. The following graph (see Figure 7-1 on page 7-7) shows the range and accuracy for a single channel inputted or bandpass filter and the noise measured with the carrier and modulation off.	

CSO and CTB Distortion*	Manual composite second order (CSO) and composite triple beat (CTB) distortions are measured relative to the visual carrier peak and require momentary disabling of the carrier. Automatic measurements are made in the channel above the channel selected and assumes that it is unused.
Optimum Input Range	See Graphs [†]
Maximum CSO/CTB Range	Input level dependent - See Graphs [†] 70 to 75 dB over optimum input range
Manual CSO/CTB Resolution	0.1 dB
System CSO/CTB Resolution	1 dB
CSO/CTB Accuracy	Input level and measured CSO/CTB dependent - See graphs ± 1.5 dB to ± 4.0 dB over optimum input range
*A preamplifier and preselector filter may be required to achieve specifications.	
[†] Optimum input range is determined at the time of measurement since a total input power measurement is first done to automatically set the attenuator.	

C/N, CSO, and CTB Measurements

The following graphs summarize the ESA Option 227 characteristics for C/N, CSO, and CTB testing on cable TV systems with up to 99 channels and no amplitude tilt. C/N, CSO, and CTB measurement accuracies and ranges can be read from the relevant graphs. They depend upon the visual carrier peak level, the measurement reading, and the total power input to the analyzer. See [Chapter 6](#), “[Test Descriptions](#),” for test descriptions for each test.

Figure 7-1 Accuracy and Characteristics

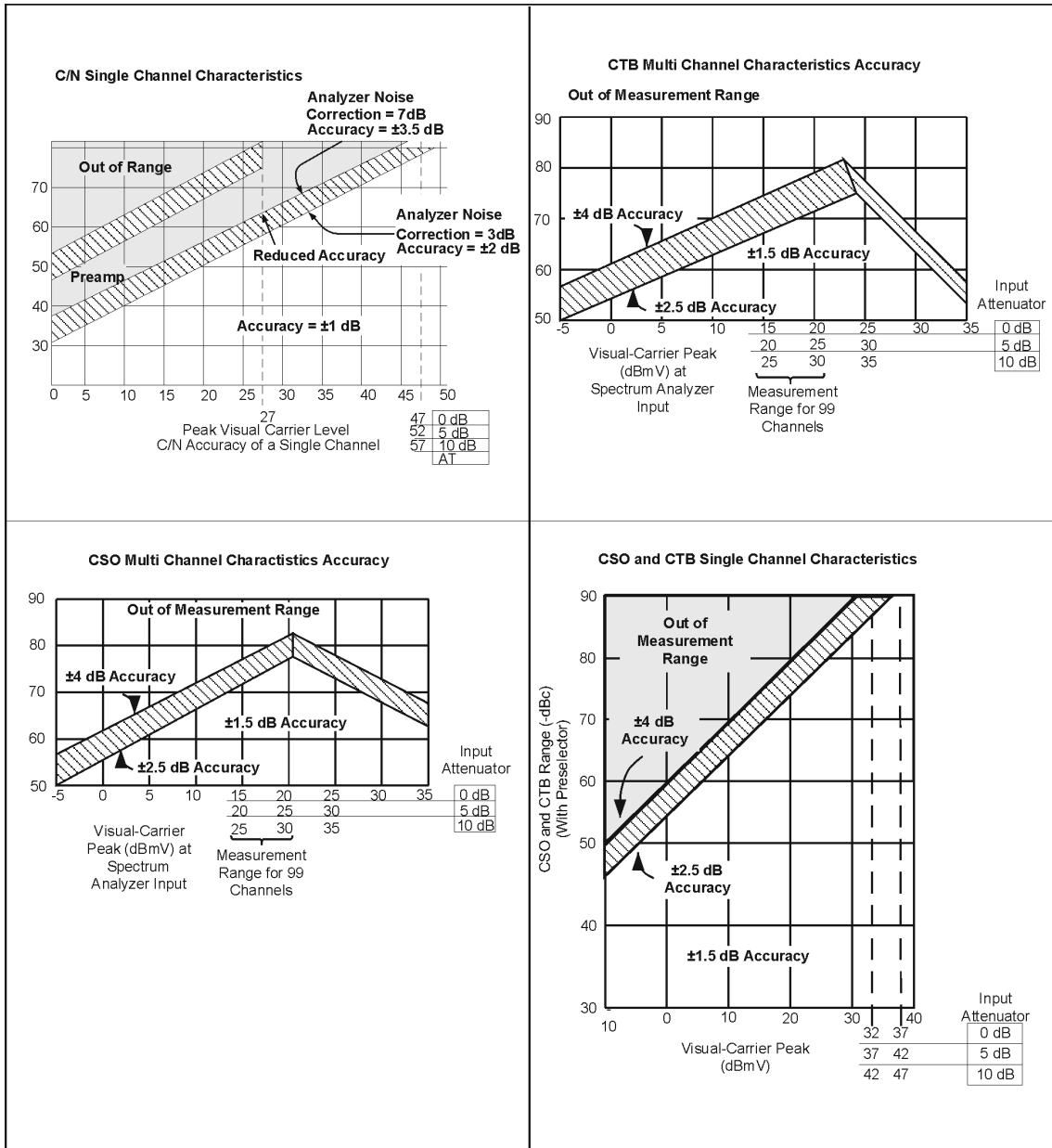

p1739b

NOTE: Noise and distortion are measured with modulation and carrier off.

Channel Identification Plans

Table 7-1

FCC Numerical Designation of Television Channels
(Section 73.603)

Channel Number	Frequency Band (MHz)
2	54-60
3	60-66
4	66-72
5	76-82
6	82-88
7	174-180
8	180-186
9	186-192
10	192-198
11	198-204
12	204-210
13	210-216
14	470-476
15	476-482
16	482-488
17	488-494
18	494-500
19	500-506
20	506-512
21	512-518
22	518-524
23	524-530
24	530-536
25	536-542
26	542-548
27	548-554
28	554-560

Table 7-1 **FCC Numerical Designation of Television Channels
(Section 73.603)**

Channel Number	Frequency Band (MHz)
29	560-566
30	566-572
31	572-578
32	578-584
33	584-590
34	590-596
35	596-602
36	602-608
37	608-614
38	614-620
39	620-626
40	626-632
41	632-638
42	638-644
43	644-650
44	650-656
45	656-662
46	662-668
47	668-674
48	674-680
49	680-686
50	686-692
51	692-698
52	698-704
53	704-710
54	710-716
55	716-722
56	722-728
57	728-734

Table 7-1

**FCC Numerical Designation of Television Channels
(Section 73.603)**

Channel Number	Frequency Band (MHz)
58	734-740
59	740-746
60	746-752
61	752-758
62	758-764
63	764-770
64	770-776
65	776-782
66	782-788
67	788-794
68	794-800
69	800-806

Table 7-2

Channel Identification Plan EIA Interim Standard No. 6 (CP) and FCC Part 76.612

Channel Designation	Picture Carrier Frequency (MHz)			Historical Reference
	STD	HRC	IRC	
1	N/A	72.0036	73.2625	4+, A-8
2	55.25	54.0027	55.2625	
3	61.25	60.0030	61.2625	
4	67.25	66.0033	67.2625	
5	77.25	78.0039	79.2625	A-7(HRC,IRC)
6	83.25	84.0042	85.2625	A-6(HRC,IRC)
7	175.25	174.0087	175.2625	
8	181.25	180.0090	181.2625	
9	187.25	186.0093	187.2625	
10	193.25	192.0096	193.2625	
11	199.25	198.0099	199.2625	
12	205.25	204.0102	205.2625	
13	211.25	210.0105	211.2625	
14	121.2625	120.0060	121.2625	A
15	127.2625	126.0063	127.2625	B
16	133.2625	132.0066	133.2625	C
17	139.25	138.0069	139.2625	D
18	145.25	144.0072	145.2625	E
19	151.25	150.0075	151.2625	F
20	157.25	156.0078	157.2625	G
21	163.25	162.0081	163.2625	H
22	169.25	168.0084	169.2625	I
23	217.25	216.0108	217.2625	J
24	223.25	222.0111	223.2625	K
25	229.2625	228.0114	229.2625	L
26	235.2625	234.0117	235.2625	M
27	241.2625	240.0120	241.2625	N

Specifications and Test Aids
Channel Identification Plans

Table 7-2

Channel Identification Plan EIA Interim Standard No. 6 (CP) and FCC Part 76.612

Channel Designation	Picture Carrier Frequency (MHz)			Historical Reference
	STD	HRC	IRC	
28	247.2625	246.0123	247.2625	O
29	253.2625	252.0126	253.2625	P
30	259.2625	258.0129	259.2625	Q
31	265.2625	264.0132	265.2625	R
32	271.2625	270.0135	271.2625	S
33	277.2625	276.0138	277.2625	T
34	283.2625	282.0141	283.2625	U
35	289.2625	288.0144	289.2625	V
36	295.2625	294.0147	295.2625	W
37	301.2625	300.0150	301.2625	X
38	307.2625	306.0153	307.2625	Y
39	313.2625	312.0156	313.2625	Z
40	319.2625	318.0159	319.2625	DD
41	325.2625	324.0162	325.2625	EE
42	331.2750a	330.0165	331.2750a	FF
43	337.2625	336.0168	337.2625	GG
44	343.2625	342.0171	343.2625	HH
45	349.2625	348.0174	349.2625	II
46	355.2625	354.0177	355.2625	JJ
47	361.2625	360.0180	361.2625	KK
48	367.2625	366.0183	367.2625	LL
49	373.2625	372.0186	373.2625	MM
50	379.2625	378.0189	379.2625	NN
51	385.2625	384.0192	385.2625	OO
52	391.2625	390.0195	391.2625	PP
53	397.2625	396.0198	397.2625	QQ
54	403.25	402.0201	403.2625	RR

Table 7-2

Channel Identification Plan EIA Interim Standard No. 6 (CP) and FCC Part 76.612

Channel Designation	Picture Carrier Frequency (MHz)			Historical Reference
	STD	HRC	IRC	
55	409.25	408.0204	409.2625	SS
56	415.25	414.0207	415.2625	TT
57	421.25	420.0210	421.2625	UU
58	427.25	426.0213	427.2625	VV
59	433.25	432.0216	433.2625	WW
60	439.25	438.0219	439.2625	XX
61	445.25	444.0222	445.2625	YY
62	451.25	450.0225	451.2625	ZZ
63	457.25	456.0228	457.2625	
64	463.25	462.0231	463.2625	
65	469.25	468.0234	469.2625	
66	475.25	474.0237	475.2625	
67	481.25	480.0240	481.2625	
68	487.25	486.0243	487.2625	
69	493.25	492.0246	493.2625	
70	499.25	498.0249	499.2625	
71	505.25	504.0252	505.2625	
72	511.25	510.0255	511.2625	
73	517.25	516.0258	517.2625	
74	523.25	522.0261	523.2625	
75	529.25	528.0264	529.2625	
76	535.25	534.0267	535.2625	
77	541.25	540.0270	541.2625	
78	547.25	546.0273	547.2625	
79	553.25	552.0276	553.2625	
80	559.25	558.0279	559.2625	
81	565.25	564.0282	565.2625	

Specifications and Test Aids
Channel Identification Plans

Table 7-2

Channel Identification Plan EIA Interim Standard No. 6 (CP) and FCC Part 76.612

Channel Designation	Picture Carrier Frequency (MHz)			Historical Reference
	STD	HRC	IRC	
82	571.25	570.0285	571.2625	
83	577.25	576.0288	577.2625	
84	583.25	582.0291	583.2625	
85	589.25	588.0294	589.2625	
86	595.25	594.0297	595.2625	
87	601.25	600.0300	601.2625	
88	607.25	606.0303	607.2625	
89	613.25	612.0306	613.2625	
90	619.25	618.0309	619.2625	
91	625.25	624.0312	625.2625	
92	631.25	630.0315	631.2625	
93	637.25	636.0318	637.2625	
94	643.25	642.0321	643.2625	
95	91.25	90.0045	91.2625	A-5
96	97.25	96.0048	97.2625	A-4
97	103.25	102.0051	103.2625	A-3
98	109.2750a	108.0250	109.2750a	A-2
99	115.2750a	114.0250	115.2750a	A-1
100	649.2500	648.0324	649.2625	
101	655.2500	654.0327	655.2625	
102	661.2500	660.0330	661.2625	
103	667.2500	666.0333	667.2625	
104	673.2500	672.0336	673.2625	
105	679.2500	678.0339	679.2625	
106	685.2500	684.0342	685.2625	
107	691.2500	690.0345	691.2625	
108	697.2500	696.0348	697.2625	

Table 7-2

Channel Identification Plan EIA Interim Standard No. 6 (CP) and FCC Part 76.612

Channel Designation	Picture Carrier Frequency (MHz)			Historical Reference
	STD	HRC	IRC	
109	703.2500	702.0351	703.2625	
110	709.2500	708.0354	709.2625	
111	715.2500	714.0357	715.2625	
112	721.2500	720.0360	721.2625	
113	727.2500	726.0363	727.2625	
114	733.2500	732.0366	733.2625	
115	739.2500	738.0369	739.2625	
116	745.2500	744.0372	745.2625	
117	751.2500	750.0375	751.2625	
118	757.2500	756.0378	757.2625	
119	763.2500	762.0381	763.2625	
120	769.2500	768.0384	769.2625	
121	775.2500	774.0387	775.2625	
122	781.2500	780.0390	781.2625	
123	787.2500	786.0393	787.2625	
124	793.2500	792.0396	793.2625	
125	799.2500	798.0399	799.2625	
126	805.2500	804.0402	805.2625	
127	811.2500	810.0405	811.2625	
128	817.2500	816.0408	817.2625	
129	823.2500	822.0411	823.2625	
130	829.2500	828.0414	829.2625	
131	835.2500	834.0417	835.2625	
132	841.2500	840.0420	841.2625	
133	847.2500	846.0423	847.2625	
134	853.2500	852.0426	853.2625	
135	859.2500	858.0429	859.2625	

Specifications and Test Aids
Channel Identification Plans

Table 7-2

Channel Identification Plan EIA Interim Standard No. 6 (CP) and FCC Part 76.612

Channel Designation	Picture Carrier Frequency (MHz)			Historical Reference
	STD	HRC	IRC	
136	865.2500	864.0432	856.2625	
137	871.2500	870.0435	871.2625	
138	877.2500	876.0438	877.2625	
139	883.2500	882.0441	883.2625	
140	889.2500	888.0444	889.2625	
141	895.2500	894.0447	895.2625	
142	901.2500	900.0450	901.2625	
143	907.2500	906.0453	907.2625	
144	913.2500	912.0456	913.2625	
145	919.2500	918.0459	919.2625	
146	925.2500	924.0462	925.2625	
147	931.2500	930.0465	931.2625	
148	937.2500	936.0468	937.2625	
149	943.2500	942.0471	943.2625	
150	949.2500	948.0474	949.2625	
151	955.2500	954.0477	955.2625	
152	961.2500	960.0480	961.2625	
153	967.2500	966.0483	967.2625	
154	973.2500	972.0486	973.2625	
155	979.2500	978.0489	979.2625	
156	985.2500	984.0492	985.2625	
157	991.2500	990.0495	991.2625	
158	997.2500	996.0498	997.2625	

a. This frequency deviates from the pattern.

Table 7-3 **T-Channels (NTSC-M)**

Channel	Standard		
	Video	Color	Sound
T7	7.00	10.58	11.50
T8	13.00	16.58	17.50
T9	19.00	22.58	23.50
T10	25.00	28.58	29.50
T11	31.00	34.58	35.50
T12	37.00	40.58	41.50
T13	43.00	46.58	47.50

Specifications and Test Aids
Channel Identification Plans

Table 7-4

Air Channels (NTSC-J)

Channel Number	Frequency Band (MHz)	Picture Carrier (MHz)	Audio Carrier (MHz)
1	90-96	91.25	95.75
2	96-102	97.25	101.75
3	102-108	103.25	107.75
4	170-176	171.25	175.75
5	176-182	177.25	181.75
6	182-188	183.25	187.75
7	188-194	189.25	193.75
8	192-198 ^a	193.25	197.75
9	198-204	199.25	203.75
10	204-210	205.25	209.75
11	210-216	211.25	215.75
12	216-222	217.25	221.75
13	470-476	471.25	475.75
14	476-482	477.25	481.75
15	482-488	483.25	487.75
16	488-494	489.25	493.75
17	494-500	495.25	499.75
18	500-506	501.25	505.75
19	506-512	507.25	511.75
20	512-518	513.25	517.75
21	518-524	519.25	523.75
22	524-530	515.25	529.75
23	530-536	531.25	535.75
24	536-542	537.25	541.75
25	542-548	543.25	547.75
26	548-554	549.25	553.75
27	554-560	555.25	559.75
28	560-566	561.25	565.75

Table 7-4 Air Channels (NTSC-J)

Channel Number	Frequency Band (MHz)	Picture Carrier (MHz)	Audio Carrier (MHz)
29	566-572	567.25	571.75
30	572-578	573.25	577.75
31	578-584	579.25	583.75
32	584-590	585.25	589.75
33	590-596	591.25	595.75
34	596-602	597.25	601.75
35	602-608	603.25	607.75
36	608-614	609.25	613.75
37	614-620	615.25	619.75
38	620-626	621.25	625.75
39	626-632	627.25	631.75
40	632-638	633.25	637.75
41	638-644	639.25	643.75
42	644-650	645.25	649.75
43	650-656	651.25	655.75
44	656-662	657.25	661.75
45	662-668	663.25	667.75
46	668-674	669.25	673.75
47	674-680	675.25	679.75
48	680-686	681.25	685.75
49	686-692	687.25	691.75
50	692-698	693.25	697.75
51	698-704	699.25	703.75
52	704-710	705.25	709.75
53	710-716	711.25	715.75
54	716-722	717.25	721.75
55	722-728	723.25	728.75
56	728-734	729.25	733.75

Specifications and Test Aids
Channel Identification Plans

Table 7-4

Air Channels (NTSC-J)

Channel Number	Frequency Band (MHz)	Picture Carrier (MHz)	Audio Carrier (MHz)
57	734-740	735.25	739.75
58	740-746	741.25	745.75
59	746-752	747.25	751.75
60	752-758	753.25	757.75
61	758-764	759.25	763.75
62	764-770	765.25	769.75

a. This frequency deviates from the pattern.

Table 7-5

CBL Channels NTSC-J

Band	Channel Number	Frequency Band (MHz)	Picture Carrier (MHz)	Audio Carrier (MHz)
Mid Band	13	108–114	109.25	113.75
	14	114–120	115.25	119.75
	15	120–126	121.25	125.75
	16	126–132	127.25	131.75
	17	132–138	133.25	137.75
	18	138–144	139.25	143.75
	19	144–150	145.25	149.75
	20	150–156	151.25	155.75
	21	156–162	157.25	161.75
	22	164–170	165.25	169.75
Super High Band	23	222–228	223.25	227.75
	24	230–236	231.25	235.75
	25	236–242	237.25	241.75
	26	242–248	243.25	247.75
	27	248–254	249.25	253.75
	28	252–258	253.25	257.75
	29	258–264	259.25	263.75
	30	264–270	265.25	269.75

Table 7-5

CBL Channels NTSC-J

Band	Channel Number	Frequency Band (MHz)	Picture Carrier (MHz)	Audio Carrier (MHz)
Super High Band	31	270–276	271.25	275.75
	32	276–282	277.25	281.75
	33	282–288	283.25	287.75
	34	288–294	289.25	293.75
	35	294–300	295.25	299.75
	36	300–306	301.25	305.75
	37	306–313	307.25	311.75
	38	312–318	313.25	317.75
	39	318–324	319.25	323.75
	40	324–330	325.25	329.75
	41	330–336	331.25	335.75
	42	336–342	337.25	341.75
	43	342–348	343.25	347.75
	44	348–354	349.25	353.75
	45	354–360	355.25	359.75
	46	360–366	361.25	365.75
	47	366–372	367.25	371.75
	48	372–378	373.25	377.75
	49	378–384	379.25	383.75
	50	384–390	385.25	389.75
51	390–396	391.25	395.75	
52	396–402	397.25	401.75	
53	402–408	403.25	407.75	

Table 7-5 CBL Channels NTSC-J

Band	Channel Number	Frequency Band (MHz)	Picture Carrier (MHz)	Audio Carrier (MHz)
Super High Band	54	408–414	409.25	413.75
	55	414–420	415.25	419.75
	56	420–426	421.25	425.75
	57	426–432	427.25	431.75
	58	432–438	433.25	437.75
	59	438–444	439.25	443.75
	60	444–450	445.25	449.75
	61	450–456	451.25	455.75
	62	456–462	457.25	461.75
	63	462–468	463.25	467.75

Specifications and Test Aids
Channel Identification Plans

Table 7-6

CCIR VHF Channels (7 MHz) (PAL B,C)

Band	Channel	Channel Limits (MHz)	Vision Carrier (MHz)	Sound Carrier (MHz)
IF		33.15-40.15	38.9	33.4
I	E2	47-54	48.25	53.75
-	E3	54-61	55.25	60.75
-	E4	61-68	62.25	67.75
III	E5	174-181	175.25	180.75
-	E6	181-188	182.25	187.75
-	E7	188-195	189.25	194.75
-	E8	195-202	196.25	210.75
-	E9	202-209	203.25	208.75
-	E10	209-216	210.25	215.75
-	E11	216-223	217.25	222.75
-	E12	223-230	224.25	229.75

Table 7-7

VHF Channels (8 MHz) (PAL-I)

Channel	Channel Limits (MHz)	Vision Carrier (MHz)	Sound Carrier (MHz)
1	44.5-52.5	45.75	51.75
2	52.5-60.5	53.75	59.75
3	60.5-68.5	61.75	67.75
4	174-182	175.25	181.25
5	182.190	183.25	183.25
6	190-198	191.25	197.25
7	198-206	199.25	205.25
8	206-214	207.25	213.25
9	214-222	215.25	221.25
10	222-230	223.25	229.25
11	230-238	231.25	237.25
12	238-246	239.25	245.25
13	245-254	247.43	253.43

Table 7-8

CCIR S Channels (7 MHz, 8 MHz) (PAL B,C)

Band	Channel	Channel Limits (MHz)	Vision Carrier (MHz)	Sound Carrier (MHz)
IF		33.15-40.15	38.9	33.4
L21	S1	104-111	105.25	110.75
	S2	111-118	112.25	117.75
	S3	118-125	119.25	124.75
	S4	125-132	126.25	131.75
	S5	132-139	133.25	138.75
	S6	139-146	140.25	145.75
	S7	146-153	147.25	152.75
	S8	153-160	154.25	159.75
	S9	160-167	161.25	166.75
	S10	167-174	168.25	173.75
U21	S11	230-237	231.25	236.75
	S12	237-244	238.25	243.75
	S13	244-251	245.25	250.75
	S14	251-258	252.25	257.75
	S15	258-265	259.25	264.75
	S16	265-272	266.25	271.75
	S17	272-279	273.25	278.75
	S18	279-286	280.25	285.75
	S19	286-293	287.25	292.75
	S20	293-300	294.25	299.75
	S21	302-310	303.25	308.75
	S22	310-318	311.25	316.75
	S23	318-326	319.25	324.75
	S24	326-334	327.25	332.75
	S25	334-342	335.25	340.75
	S26	342-350	343.25	348.75
	S27	350-358	351.25	356.75
	S28	358-366	359.25	364.75
	S29	366-374	367.25	372.75

Specifications and Test Aids
Channel Identification Plans

Table 7-8

CCIR S Channels (7 MHz, 8 MHz) (PAL B,C)

Band	Channel	Channel Limits (MHz)	Vision Carrier (MHz)	Sound Carrier (MHz)
	S30	374-382	375.25	380.75
	S31	382-390	383.25	388.75
	S32	390-398	391.25	396.75
	S33	398-406	399.25	404.75
	S34	406-414	407.25	412.75
	S35	414-422	415.25	420.75
	S36	422-430	423.25	428.75
	S37	430-438	431.25	436.75
	S38	438-446	439.25	444.75
	S39	446-454	447.25	452.75
	S40	454-462	455.25	460.75
	S41	462-470	463.25	468.75

Table 7-9

CCIR S-Cable Channels (7 MHz) (PAL B,C)

Band	Channel	Channel Limits (MHz)	Vision Carrier (MHz)	Sound Carrier (MHz)
IF		33.15-40.15	38.9	33.4
II	S1	104-111	105.25	110.75
	S2	111-118	112.25	117.75
	S3	118-125	119.25	124.75
	S4	125-132	126.25	131.75
	S5	132-139	133.25	138.75
	S6	139-146	140.25	145.75
	S7	146-153	147.25	152.75
	S8	153-160	154.25	159.75
	S9	160-167	161.25	166.75
	S10	167-174	168.25	173.75
U21	S11	230-237	231.25	236.75
	S12	237-244	238.25	243.75
	S13	244-251	245.25	250.75
	S14	251-258	252.25	257.75
	S15	258-265	259.25	264.75
	S16	265-272	266.25	271.75
	S17	272-279	273.25	278.75
	S18	279-286	280.25	285.75
	S19	286-293	287.25	292.75
	S20	293-300	294.25	299.75
	S21	300-307	301.25	306.75
	S22	307-314	311.25	316.75
	S23	314-321	315.25	320.75
	S24	321-328	322.25	327.75
	S25	328-335	329.25	334.75
	S26	335-342	336.25	341.75
	S27	342-349	343.25	348.75
	S28	349-356	350.25	355.75
	S29	356-363	357.25	362.75

Specifications and Test Aids
Channel Identification Plans

Table 7-9

CCIR S-Cable Channels (7 MHz) (PAL B,C)

Band	Channel	Channel Limits (MHz)	Vision Carrier (MHz)	Sound Carrier (MHz)
	S30	363-370	364.25	369.75
	S31	370-377	371.25	376.75
	S32	377-384	378.25	383.75
	S33	384-391	385.25	390.75
	S34	391-398	392.25	397.75
	S35	398-405	399.25	404.75
	S36	405-412	406.25	411.75
	S37	412-419	413.25	418.75
	S38	419-426	420.25	425.75
	S39	426-433	427.25	432.75
	S40	433-440	434.25	439.75
	S41	440-447	441.25	446.75
	S42	447-454	448.25	453.75
	S43	454-461	455.25	460.75
	S44	461-468	462.25	467.75

Table 7-10 CCIR UHF Channels (8 MHz) (PAL G,H,I,K,L)

Band	Channel	Channel Limits (MHz)	Vision Carrier (MHz)	Sound Carrier (MHz)		
				G,H	I	K,L
IF	same as VHF for corresponding country					
IV	21	470-478	471.25	476.75	477.25	477.75
	22	478-486	479.25	484.75	485.25	485.75
	23	486-494	487.25	492.75	493.25	493.75
	24	494-502	495.25	500.75	501.25	501.75
	25	502-510	503.25	508.75	509.25	509.75
	26	510-518	511.25	516.75	517.25	517.75
	27	518-526	519.25	524.75	525.25	525.75
	28	526-534	527.25	532.75	533.25	533.75
	29	534-542	535.25	540.75	541.25	541.75
	30	542-550	543.25	548.75	549.25	549.75
	31	550-558	551.25	556.75	557.25	557.75
	32	558-566	559.25	564.75	565.25	565.75
	33	566-574	567.25	572.75	573.25	573.75
	34	574-582	575.25	580.75	581.25	581.75
	35	582-590	583.25	588.75	589.25	589.75
	36	590-598	591.25	596.75	597.25	597.75
	37	598-606	599.25	604.75	605.25	605.75
V	38	606-614	607.25	612.75	613.25	613.75
	39	614-622	615.25	620.75	621.25	621.75
	40	622-630	623.25	628.75	629.25	629.75
	41	630-638	631.25	636.75	637.25	637.75
	42	638-646	639.25	644.75	645.25	645.75
	43	646-654	647.25	652.75	653.25	653.75
	44	654-662	655.25	660.75	661.25	661.75
	45	662-670	663.25	668.75	669.25	669.75
	46	670-678	671.25	676.75	677.25	677.75
	47	678-686	679.25	684.755	685.25	685.75
	48	686-694	687.25	692.75	693.25	693.75

Specifications and Test Aids
Channel Identification Plans

Table 7-10 CCIR UHF Channels (8 MHz) (PAL G,H,I,K,L)

Band	Channel	Channel Limits (MHz)	Vision Carrier (MHz)	Sound Carrier (MHz)		
	49	694-702	695.25	700.75	701.25	701.75
	50	702-710	703.25	708.75	709.25	709.75
	51	710-718	711.25	716.75	717.25	717.75
	52	718-726	719.25	708.75	709.25	709.75
	53	726-734	727.25	732.75	733.25	733.75
	54	734-742	735.25	740.75	741.25	741.75
	55	742-750	743.25	748.75	749.25	749.75
	56	750-758	751.25	756.75	757.25	757.75
	57	758-766	759.25	764.75	765.25	765.75
	58	766-774	767.25	772.75	773.25	773.75
	59	774-782	775.25	780.75	781.25	781.75
	60	782-790	783.25	788.75	789.25	789.75
	61	790-798	791.25	796.75	797.25	797.75
	62	798-806	799.25	804.75	805.25	805.75
	63	806-814	807.25	812.75	813.25	813.75
	64	814-822	815.25	820.75	821.25	821.75
	65	822-830	823.25	828.75	829.25	829.75
	66	830-838	831.25	836.75	837.25	837.75
	67	838-846	839.25	844.75	845.25	845.75
	68	846-854	847.25	852.75	853.25	853.75
	69	854-862	855.25	860.75	861.25	861.75

Table 7-11 HRC Channels (8 MHz) (PAL B/G, I)

Channel	Channel Limits (MHz)		Vision Carrier (MHz)	Sound Carrier (MHz)	
	Lower	Upper		B/G	I
2	54.75	62.75	56	61.5	62
3	62.75	70.75	64	69.5	70
4	70.75	78.75	72	77.5	78
5	78.75	86.75	80	85.5	86
6	86.75	94.75	88	93.5	94
7	94.75	102.75	96	101.5	102
8	102.75	110.75	104	109.5	110
9	110.75	118.75	112	117.5	118
10	118.75	126.75	120	125.5	126
11	126.75	134.75	128	133.5	134
12	134.75	142.75	136	141.5	142
13	142.75	150.75	144	149.5	150
14	150.75	158.75	152	157.5	158
15	158.75	166.75	160	165.5	166
16	166.75	174.75	168	173.5	174
17	174.75	182.75	176	181.5	182
18	182.75	190.75	184	189.5	190
19	190.75	198.75	192	197.5	198
20	198.75	206.75	200	205.5	206
21	206.75	214.75	208	213.5	214
22	214.75	222.75	216	221.5	222
23	222.75	230.75	224	229.5	230
24	230.75	238.75	232	237.5	238
25	238.75	246.75	240	245.5	246
26	246.75	254.75	248	253.5	254
27	254.75	262.75	256	261.5	262
28	262.75	270.75	264	269.5	270
29	270.75	278.75	272	277.5	278
30	278.75	286.75	280	285.5	286

Specifications and Test Aids
Channel Identification Plans

Table 7-11 HRC Channels (8 MHz) (PAL B/G, I)

Channel	Channel Limits (MHz)		Vision Carrier (MHz)	Sound Carrier (MHz)	
31	286.75	294.75	288	293.5	294
32	294.75	302.75	296	301.5	302
33	302.75	310.75	304	309.5	310
34	310.75	318.75	312	317.5	318
35	318.75	326.75	320	325.5	326
36	326.75	334.75	328	333.5	334
37	334.75	342.75	336	341.5	342
38	342.75	350.75	344	349.5	350
39	350.75	358.75	352	357.5	358
40	358.75	366.75	360	365.5	366
41	366.75	374.75	368	373.5	374
42	374.75	382.75	376	381.5	382
43	382.75	390.75	384	389.5	390
44	390.75	398.75	392	397.5	398
45	398.75	406.75	400	405.5	406
46	406.75	414.75	408	413.5	414
47	414.75	422.75	416	421.5	422
48	422.75	430.75	424	429.5	430
49	430.75	438.75	432	437.5	438
50	438.75	446.75	440	445.5	446
51	446.75	454.75	448	453.5	454
52	454.75	462.75	456	461.5	462
53	462.75	470.75	464	469.5	470
54	470.75	478.75	472	477.5	478
55	478.75	486.75	480	485.5	486
56	486.75	494.75	488	493.5	494
57	494.75	502.75	496	501.5	502
58	502.75	510.75	504	509.5	510
59	510.75	518.75	512	517.5	518
60	518.75	526.75	520	525.5	526

Table 7-11 HRC Channels (8 MHz) (PAL B/G, I)

Channel	Channel Limits (MHz)		Vision Carrier (MHz)	Sound Carrier (MHz)	
61	526.75	534.75	528	533.5	534
62	534.75	542.75	536	541.5	542
63	542.75	550.75	544	549.5	550
64	550.75	558.75	552	557.5	558
65	558.75	560.75	560	559.5	560
66	560.75	574.75	562	573.5	574
67	574.75	582.75	576	581.5	582
68	582.75	590.75	584	589.5	590
69	590.75	598.75	592	597.5	598
70	598.75	606.75	600	605.5	606
71	606.75	614.75	608	613.5	614
72	614.75	622.75	616	621.5	622
73	622.75	630.75	624	629.5	630
74	630.75	638.75	632	637.5	638
75	638.75	646.75	640	645.5	646
76	646.75	654.75	648	653.5	654
77	654.75	662.75	656	661.5	662
78	662.75	630.75	664	669.5	670
79	670.75	678.75	672	677.5	678
80	678.75	686.75	680	685.5	686
81	686.75	694.75	688	693.5	694
82	694.75	702.75	696	701.5	702
83	702.75	710.75	704	709.5	710
84	710.75	718.75	712	717.5	718
85	718.75	726.75	720	725.5	726
86	726.75	734.75	728	733.5	734
87	734.75	742.75	736	741.5	742
88	742.75	750.75	744	749.5	750
89	750.75	758.75	752	757.5	758
90	758.75	766.75	760	765.5	766

Specifications and Test Aids
Channel Identification Plans

Table 7-11 HRC Channels (8 MHz) (PAL B/G, I)

Channel	Channel Limits (MHz)		Vision Carrier (MHz)	Sound Carrier (MHz)	
91	766.75	774.75	768	773.5	774
92	774.75	782.75	776	781.5	782
93	782.75	790.75	784	789.5	790
94	790.75	798.75	792	797.5	798
95	798.75	806.75	800	805.5	806
96	806.75	814.75	808	813.5	814
97	814.75	822.75	816	821.5	822
98	822.75	830.75	824	829.5	830
99	830.75	838.75	832	837.5	838
100	838.75	846.75	840	845.5	846
101	846.75	854.75	848	853.5	854
102	854.75	862.75	856	861.5	862
103	862.75	870.75	864	869.5	870
104	870.75	878.75	872	877.5	878
105	878.75	886.75	880	885.5	886
106	886.75	894.75	888	893.5	894
107	894.75	902.75	896	901.5	902
108	902.75	910.75	904	909.5	910
109	910.75	918.75	912	917.5	918
110	918.75	926.75	920	925.5	926
111	926.75	934.75	928	933.5	934
112	934.75	942.75	936	941.5	942
113	942.75	950.75	944	949.5	950
114	950.75	958.75	952	957.5	958
115	958.75	966.75	960	965.5	966
116	966.75	974.75	968	973.5	974
117	974.75	982.75	976	981.5	982
118	982.75	990.75	984	989.5	990
119	990.75	998.75	992	997.5	998
120	998.75	1006.75	1000	1005.5	1006

Table 7-11 HRC Channels (8 MHz) (PAL B/G, I)

Channel	Channel Limits (MHz)		Vision Carrier (MHz)	Sound Carrier (MHz)	
121	1006.75	1014.75	1008	1013.5	1014
122	1014.75	1022.75	1016	1021.5	1022
123	1022.75	1030.75	1024	1029.5	1030
124	1030.75	1038.75	1032	1037.5	1038
125	1038.75	1046.75	1040	1045.5	1046
126	1046.75	1054.75	1048	1053.5	1054
127	1054.75	1062.75	1052	1061.5	1062
128	1062.75	1070.75	1064	1069.5	1070
129	1070.75	1078.75	1072	1077.5	1078
130	1078.75	1086.75	1080	1085.5	1086
131	1086.75	1094.75	1088	1093.5	1094
132	1094.75	1102.75	1096	1101.5	1102
133	1102.75	1110.75	1104	1109.5	1110
134	1110.75	1118.75	1112	1117.5	1118
135	1118.75	1126.75	1120	1125.5	1126
136	1126.75	1134.75	1128	1133.5	1134
137	1134.75	1142.75	1136	1141.5	1142
138	1142.75	1150.75	1144	1149.5	1150
139	1150.75	1158.75	1152	1157.5	1158
140	1158.75	1166.75	1160	1165.5	1166
141	1166.75	1174.75	1168	1173.5	1174
142	1174.75	1182.75	1176	1181.5	1182
143	1182.75	1190.75	1184	1189.5	1190
144	1190.75	1198.75	1192	1197.5	1198
145	1198.75	1206.75	1200	1205.5	1206
146	1206.75	1214.75	1208	1213.5	1214
147	1214.75	1222.75	1216	1221.5	1222
148	1222.75	1230.75	1224	1229.5	1230
149	1230.75	1238.75	1232	1237.5	1238
150	1238.75	1246.75	1240	1245.5	1246

Specifications and Test Aids
Channel Identification Plans

Table 7-11 HRC Channels (8 MHz) (PAL B/G, I)

Channel	Channel Limits (MHz)		Vision Carrier (MHz)	Sound Carrier (MHz)	
151	1246.75	1254.75	1248	1253.5	1254
152	1254.75	1262.75	1256	1261.5	1262
153	1262.75	1270.75	1264	1269.5	1270
154	1270.75	1278.75	1272	1277.5	1278
155	1278.75	1286.75	1280	1285.5	1286
156	1286.75	1294.75	1288	1293.5	1294
157	1294.75	1302.75	1296	1301.5	1302
158	1302.75	1310.75	1304	1309.5	1310
159	1310.75	1318.75	1312	1317.5	1318
160	1318.75	1326.75	1320	1325.5	1326
161	1326.75	1334.75	1328	1333.5	1334
162	1334.75	1342.75	1336	1341.5	1342
163	1342.75	1350.75	1344	1349.5	1350
164	1350.75	1358.75	1352	1357.5	1358
165	1358.75	1366.75	1360	1365.5	1366
166	1366.75	1374.75	1368	1373.5	1374
167	1374.75	1382.75	1376	1381.5	1382
168	1382.75	1390.75	1384	1389.5	1390
169	1390.75	1398.75	1392	1397.5	1398
170	1398.75	1406.75	1400	1405.5	1406
171	1406.75	1414.75	1408	1413.5	1414
172	1414.75	1422.75	1416	1421.5	1422
173	1422.75	1430.75	1424	1429.5	1430
174	1430.75	1438.75	1432	1437.5	1438
175	1438.75	1446.75	1440	1445.5	1446
176	1446.75	1454.75	1448	1453.5	1454
177	1454.75	1462.75	1456	1461.5	1462
178	1462.75	1470.75	1464	1469.5	1470
179	1470.75	1478.75	1472	1477.5	1478
180	1478.75	1486.75	1480	1485.5	1486

Table 7-11 HRC Channels (8 MHz) (PAL B/G, I)

Channel	Channel Limits (MHz)		Vision Carrier (MHz)	Sound Carrier (MHz)	
181	1486.75	1494.75	1488	1493.5	1494
182	1494.75	1502.75	1496	1501.5	1502
183	1502.75	1510.75	1504	1509.5	1510
184	1510.75	1518.75	1512	1517.5	1518
185	1518.75	1526.75	1520	1525.5	1526
186	1526.75	1534.75	1528	1533.5	1534
187	1534.75	1542.75	1536	1541.5	1542
188	1542.75	1550.75	1544	1549.5	1550
189	1550.75	1558.75	1552	1557.5	1558
190	1558.75	1566.75	1560	1565.5	1566
191	1566.75	1574.75	1568	1573.5	1574
192	1574.75	1582.75	1576	1581.5	1582
193	1582.75	1590.75	1584	1589.5	1590
194	1590.75	1598.75	1592	1597.5	1598
195	1598.75	1606.75	1600	1605.5	1606
196	1606.75	1614.75	1608	1613.5	1614
197	1614.75	1622.75	1616	1621.5	1622
198	1622.75	1630.75	1624	1629.5	1630
199	1630.75	1638.75	1632	1637.5	1638

Specifications and Test Aids
Channel Identification Plans

Table 7-12

CENELEC Channels (7 MHz, 8 MHz) (PAL B/G)

Channel	Channel Limits (MHz)		Vision Carrier (MHz)	Sound Carrier (MHz)
	Lower	Upper		
1	47	54	48.25	53.75
2	118	125	119.25	124.75
3	174	181	175.25	180.75
4	230	237	231.25	236.75
5	206	213	207.25	212.75
6	222	229	223.25	228.75
7	230	237	231.25	236.75
8	246	253	247.25	252.75
9	262	269	263.25	268.75
10	286	293	287.25	292.75
11	310	318	311.25	316.75
12	326	334	327.25	332.75
13	342	350	343.25	348.75
14	358	366	359.25	364.75
15	374	382	375.25	380.75
16	390	398	391.25	396.75
17	406	414	407.25	412.75
18	422	430	423.25	428.75
19	438	436	439.25	444.75
20	446	454	447.25	452.75
21	462	470	463.25	468.75
22	478	486	479.25	484.75
23	494	502	495.25	500.75
24	510	518	511.25	516.75
25	526	534	527.25	532.75
26	542	550	543.25	548.75
27	566	574	567.25	572.75
28	582	590	583.25	588.75
29	598	606	599.25	604.75

Table 7-12 CENELEC Channels (7 MHz, 8 MHz) (PAL B/G)

Channel	Channel Limits (MHz)		Vision Carrier (MHz)	Sound Carrier (MHz)
	Lower	Upper		
30	662	670	663.25	668.75
31	678	686	679.25	684.75
32	694	702	695.25	700.75
33	710	718	711.25	716.75
34	726	734	727.25	732.75
35	742	750	743.25	748.75
36	758	766	759.25	764.75
37	774	782	775.25	780.75
38	790	798	791.25	796.75
39	806	814	807.25	812.75
40	822	830	823.25	828.75
41	838	846	839.25	844.75
42	854	862	855.25	860.75

Specifications and Test Aids
Channel Identification Plans

Table 7-13

China PAL-D/K (8 MHz)

Channel	Channel Limits (MHz)	Vision Carrier (MHz)	Sound Carrier (MHz)
DS-1	48.5-56.5	49.75	56.25
DS-2	56.5-64.5	57.75	64.25
DS-3	64.5-72.5	65.75	72.25
DS-4	76-84	77.25	83.75
DS-5	84-92	85.25	91.75
Z-1	111-119	112.25	118.75
Z-2	119-127	120.25	126.75
Z-3	127-135	128.25	234.75
Z-4	135-143	136.25	142.75
Z-5	143-151	144.25	150.75
Z-6	151-159	152.25	158.75
Z-7	159-167	160.25	166.75
DS-6	167-175	168.25	174.25
DS-7	175-183	176.25	182.75
DS-8	183-191	184.25	190.75
DS-9	191-199	192.25	198.75
DS-10	199-207	200.25	206.75
DS-11	207-215	208.25	214.75
DS-12	215-223	216.25	222.75
Z-8	223-231	224.25	230.75
Z-9	231-239	232.25	238.75
Z-10	239-247	240.25	246.75
Z-11	247-255	248.25	254.75
Z-12	255-263	256.25	262.75
Z-13	263-271	264.25	270.75
Z-14	271-279	272.25	278.75
Z-15	279-287	280.25	286.75
Z-16	287-295	288.25	294.75
Z-17	295-303	296.25	302.75
Z-18	303-311	304.25	310.75

Table 7-13 **China PAL-D/K (8 MHz)**

Channel	Channel Limits (MHz)	Vision Carrier (MHz)	Sound Carrier (MHz)
Z-19	311-319	312.25	318.75
Z-20	319-327	320.25	326.75
Z-21	327-335	328.25	334.75
Z-22	335-343	336.25	342.75
Z-23	343-351	344.25	350.75
Z-24	351-359	352.25	358.75
Z-25	359-367	360.25	366.75
Z-26	367-375	368.25	374.75
Z-27	375-383	376.25	382.75
Z-28	383-391	384.25	390.75
Z-29	391-399	392.25	398.75
Z-30	399-407	400.25	406.75
Z-31	407-415	408.25	414.75
Z-32	415-423	416.25	422.75
Z-33	423-431	424.25	430.75
Z-34	431-439	432.25	438.75
Z-35	439-447	440.25	446.75
Z-36	447-455	448.25	454.75
Z-37	455-463	456.25	462.75
DS-13	470-478	471.25	477.75
DS-14	478-486	479.25	485.75
DS-15	486-494	487.25	493.75
DS-16	494-502	495.25	501.75
DS-17	502-510	503.25	509.75
DS-18	510-518	511.25	517.75
DS-19	518-526	519.25	525.75
DS-20	526-534	527.25	533.75
DS-21	534-542	535.25	541.75
DS-22	542-550	543.25	549.75
DS-23	550-558	551.25	557.75

Specifications and Test Aids
Channel Identification Plans

Table 7-13

China PAL-D/K (8 MHz)

Channel	Channel Limits (MHz)	Vision Carrier (MHz)	Sound Carrier (MHz)
DS-24	558-566	559.25	565.75
DS-25	606-614	607.25	613.75
DS-26	614-622	615.25	621.75
DS-27	622-630	623.25	629.75
DS-28	630-638	631.25	637.75
DS-29	638-646	638.25	645.75
DS-30	646-654	647.25	653.75
DS-31	654-662	655.25	661.75
DS-32	662-670	663.25	669.75
DS-33	670-678	671.25	677.75
DS-34	678-686	679.25	685.75
DS-35	686-694	687.25	693.75
DS-36	694-702	695.25	701.75
DS-37	702-710	703.25	709.75
DS-38	710-718	711.25	717.75
DS-39	718-726	719.25	725.75
DS-40	726-734	727.25	733.75
DS-41	734-742	735.25	741.75
DS-42	742-750	743.25	749.75
DS-43	750-758	751.25	757.75
DS-44	758-766	759.25	765.75
DS-45	766-774	767.25	773.75
DS-46	774-782	775.25	781.75
DS-47	782-790	783.25	789.75
DS-48	790-798	791.25	797.75
DS-49	798-806	799.25	805.75
DS-50	806-814	807.25	813.75
DS-51	814-822	815.25	821.75
DS-52	822-830	823.25	829.75
DS-53	830-838	831.25	837.75

Table 7-13 **China PAL-D/K (8 MHz)**

Channel	Channel Limits (MHz)	Vision Carrier (MHz)	Sound Carrier (MHz)
DS-54	838-846	839.25	845.75
DS-55	846-854	847.25	853.75
DS-56	854-862	855.25	861.75
DS-57	862-870	863.25	869.75
DS-58	870-878	871.25	877.75
DS-59	878-886	879.25	885.75
DS-60	886-894	887.25	893.75
DS-61	894-902	895.25	901.75
DS-62	902-910	903.25	909.75
DS-63	910-918	911.25	917.75
DS-64	918-926	919.25	925.75
DS-65	926-934	927.25	933.75
DS-66	934-942	935.25	941.75
DS-67	942-950	943.25	949.75
DS-68	950-958	951.25	957.75

Introduction

Review this product and related documentation to familiarize yourself with safety markings and instructions before you operate the instrument. This product has been designed and tested in accordance with international standards.

Cleaning Instructions

Clean the cabinet using a damp cloth only.

Shipping Instructions

Always transport or ship the instrument using the original packaging if possible. If not, comparable packaging must be used.

Before Applying Power

Verify that the product is configured to match the available main power source as described in the input power configuration instructions in this manual. If this product is to be powered by autotransformer, make sure the common terminal is connected to the neutral (grounded) side of the ac power supply.

Safety Information

Warnings

WARNING The **WARNING** notice denotes a hazard. It calls attention to a procedure, practice, or the like, that, if not correctly performed or adhered to, could result in personal injury. Do not proceed beyond a **WARNING** notice until the indicated conditions are fully understood and met.

Warnings applicable to this instrument are:

WARNING No operator serviceable parts inside. Refer servicing to qualified personnel. To prevent electrical shock, do not remove covers.

WARNING If this instrument is not used as specified, the protection provided by the equipment could be impaired. This instrument must be used in a normal condition (in which all means for protection are intact) only.

WARNING For continued protection against fire hazard replace line fuse only with same type and rating:

- United States—F 3A/250V, Part Number 2110-0780
- Europe—F 3.15A/250V, Part Number 2110-0655

The use of other fuses or material is prohibited.

WARNING This is a Safety Class I product (provided with a protective earthing ground incorporated in the power cord). The mains plug shall only be inserted in a socket outlet provided with a protective earth contact. Any interruption of the protective conductor, inside or outside the instrument, is likely to make the instrument dangerous. Intentional interruption is prohibited.

WARNING The power cord is connected to internal capacitors that may remain live for 5 seconds after disconnecting the plug from its power supply.

WARNING These servicing instructions are for use by qualified personnel only. To avoid electrical shock, do not perform any servicing unless you are qualified to do so.

WARNING The opening of covers or removal of parts is likely to expose dangerous voltages. Disconnect the instrument from all voltage sources while it is being opened.

WARNING This product is designed for use in Installation Category II and Pollution Degree 2 per IEC 1010 and 664 respectively.

Cautions

CAUTION The CAUTION notice denotes a hazard. It calls attention to an operating procedure, practice, or the like, which, if not correctly performed or adhered to, could result in damage to the product or loss of important data. Do not proceed beyond a CAUTION notice until the indicated conditions are fully understood and met.









Cautions applicable to this instrument are:

CAUTION Always use the three-prong ac power cord supplied with this instrument. Failure to ensure adequate earth grounding by not using this cord may cause instrument damage.

CAUTION This instrument has autoranging line voltage input; be sure the supply voltage is within the specified range.

CAUTION Ventilation Requirements: When installing the instrument in a cabinet, the convection into and out of the instrument must not be restricted. The ambient temperature (outside the cabinet) must be less than the maximum operating temperature of the instrument by 4 °C for every 100 watts dissipated in the cabinet. If the total power dissipated in the cabinet is greater than 800 watts, then forced convection must be used.

Instrument Markings

	When you see this symbol on your instrument, you should refer to the instrument instruction manual for important information.
	This symbol indicates hazardous voltages.
	The laser radiation symbol is marked on products that have a laser output.
	This symbol indicates that the instrument requires alternating current (ac) input.
	The CE mark is a registered trademark of the European Community. If it is accompanied by a year, it indicates the year the design was proven.
	The CSA mark is a registered trademark of the Canadian Standards Association.
ISM1-A	This text indicates that the instrument is an Industrial Scientific and Medical Group 1 Class A product (CISPER 11, Clause 4).
	This symbol indicates that the power line switch is ON.
	This symbol indicates that the power line switch is OFF or in STANDBY position.
	This symbol indicates the product meets the Australian Standards.



**Safety
 Earth
 Ground**

This is a Safety Class I product (provided with a protective earthing terminal). An uninterruptible safety earth ground must be provided from the main power source to the product input wiring terminals, power cord, or supplied power cord set. Whenever it is likely that the protection has been impaired, the product must be made inoperative and secured against any unintended operation.

Agilent Technologies Sales and Service Offices

UNITED STATES		
Instrument Support Center Agilent Technologies (800) 403-0801		
EUROPEAN FIELD OPERATIONS		
Headquarters Agilent Technologies S.A. 150, Route du Nant-d'Avril 1217 Meyrin 2/ Geneva Switzerland (41 22) 780.8111	France Agilent Technologies France 1 Avenue Du Canada Zone D'Activite De Courtaboeuf F-91947 Les Ulis Cedex France (33 1) 69 82 60 60	Germany Agilent Technologies GmbH Agilent Technologies Strasse 61352 Bad Homburg v.d.H Germany (49 6172) 16-0
Great Britain Agilent Technologies Ltd. Eskdale Road, Winnersh Triangle Wokingham, Berkshire RG41 5DZ England (44 118) 9696622		
INTERCON FIELD OPERATIONS		
Headquarters Agilent Technologies Company 3495 Deer Creek Rd. Palo Alto, CA 94304-1316 USA (415) 857-5027	Australia Agilent Technologies Australia Ltd. 31-41 Joseph Street Blackburn, Victoria 3130 (61 3) 895-2895	Canada Agilent Technologies (Canada) Ltd. 17500 South Service Road Trans-Canada Highway Kirkland, Quebec H9J 2X8 Canada (514) 697-4232
Japan Agilent Technologies Japan, Ltd. Measurement Assistance Center 9-1, Takakura-Cho, Hachioji-Shi, Tokyo 192-8510, Japan TEL (81) -426-56-7832 FAX (81) -426-56-7840	Singapore Agilent Technologies Singapore (Pte.) Ltd. 150 Beach Road #29-00 Gateway West Singapore 0718 (65) 291-9088	Taiwan Agilent Technologies Taiwan 8th Floor, H-P Building 337 Fu Hsing North Road Taipei, Taiwan (886 2) 712-0404
China China Agilent Technologies 38 Bei San Huan X1 Road Shuang Yu Shu Hai Dian District Beijing, China (86 1) 256-6888		

Glossary

active function The active function is the instrument's feature currently selected for use. It may be a key selection or remote-programming command.

active function readout The area of a display screen where the active function and its state are displayed. The active function is the one that was completed by the last key selection or remote-programming command.

active marker The marker on a trace that can be repositioned by front-panel controls or programming commands.

active trace The trace (commonly A, B, or C) that is being swept (updated) with incoming signal information.

air See **off-the-air tune configuration**.

amplitude accuracy The general uncertainty of an analyzer amplitude measurement, whether relative or absolute.

ASCII The acronym for American Standard Code for Information Interchange. It is an eight-part code (7 bits plus parity check) used for data (information) interchange. An ASCII value is a specific combination of bits ranging from 0 to 255 that represent characters in machine language that computers and controllers can understand.

attenuation A general term used to denote a decrease of signal magnitude in transmission from one point to another. Attenuation may be expressed as a scalar ratio of the input to the output magnitude in decibels.

aural carrier The carrier that has the audio portion of a television channel. A television channel usually contains both a visual and aural carrier. An aural carrier is sometimes referred to as a sound carrier.

carrier-to-noise ratio The ratio of the amplitude of the carrier to the noise power in the portion of the spectrum occupied by the carrier. Also referred to as the C/N ratio.

CATV Abbreviation for community antenna television or cable television system. A cable television system is a broadband communications system that provides multiple channels from centralized antennas.

character set The set of elementary symbols. These normally include both alpha and numeric codes, plus punctuation or any other symbol that may be read, stored, or written and used for organization, control, or representation of data.

command A set of instructions that are translated into instrument actions. The actions are usually made up of individual steps that together can execute an operation. Generally, for analyzers it is a sequence of code that controls some operation of an analyzer. These codes can be keyed in via a controller, or computer. Refer also to **function**.

composite second order beat Composite second order beat (CSO) is the ratio of the composite second order beat products to the peak level of the visual carrier. For an NTSC-M system using the standard tune configuration, the composite second order beat products are the distortion products that occur at ± 750 kHz and ± 1.25 MHz around the visual carrier.

composite triple beat Composite triple beat (CTB) is the ratio of the composite triple beat products to the peak level of the visual carrier. The composite triple beat products are distortion products that occur at the visual carrier frequency.

continuous sweep mode The analyzer condition where traces are automatically updated each time trigger conditions are met.

CSO Refer to **composite second order beat**.

CTB Refer to **composite triple beat**.

current trace The displayed trace on the analyzer screen.

default The preset conditions, options, or parameters of an instrument. The default state may be changed by choosing key selections or writing programming commands to use other conditions.

depth of modulation Depth of modulation measures the percentage (50 to 93% measurement range) of amplitude modulation (AM) on the visual carrier.

delta marker An analyzer mode in which a fixed reference marker is established, then a second active marker becomes available so it can be placed anywhere along the trace. A readout indicates the relative frequency separation and amplitude difference between the reference and active markers.

display dynamic range The maximum dynamic range over which both the larger and smaller signal can be viewed simultaneously on the display. For analyzers with a maximum logarithmic display of 10 dB/division, the actual dynamic range may be greater than the display dynamic range. Refer also to **dynamic range**.

display fidelity The measurement uncertainty of relative differences in amplitude on an analyzer. On purely analog analyzers (those analyzers that display trace information immediately and do not store, then recall the data to the screen), these differences are displayed on the screen and the graticule is used to evaluate the measurement. Many analyzers with digital displays (refer to digital display) have markers that can be used to measure the signal. As a result, measurement differences are stored in memory, and the ambiguity of the display is eliminated from the measurement.

DLP The abbreviation for downloadable program. A single programming command or a sequence of programming commands used to perform specific operations. DLPs can be made up of several functions, variables, and traces defined by the program creator. The DLP can be downloaded from one electronic storage medium into another and executed without a controller.

dynamic range The power ratio (dB) between the smallest and largest signals simultaneously present at the input of an analyzer that can be measured with some degree of accuracy. Dynamic range generally refers to measurement of distortion or intermodulation products.

end-of-line (EOL) readings Measurements taken at the last tap on the distribution cable.

error message A message displayed on the screen indicating missing or failed hardware, improper user operation, or other conditions that require additional attention. Generally, the requested action or operation cannot be completed until the condition is resolved.

FFT The abbreviation for Fast Fourier Transform. It is a mathematical operation performed on a time-domain signal to yield the individual spectral components that constitute the signal.

file An electronic means of storing data. The data is stored as a collection of related records. The records are organized in a file.

firmware An assembly made up of hardware and instruction code that are integrated to form a functional set that cannot be altered during normal operation. The instruction code, permanently installed in the circuitry of the instrument, is classified as ROM (read-only memory). The firmware determines the operating characteristics of the instrument or equipment. Each firmware version is identified by a revision code number, or date code.

frequency accuracy The uncertainty with which the frequency of a signal or spectral component is indicated, either in an absolute sense or relative to some other signal or spectral component. Absolute and relative frequency accuracies are specified independently.

frequency range The range of frequencies over which the analyzer performance is specified. The maximum frequency range of many microwave analyzers can be extended with the application of external mixers.

frequency resolution The ability of an analyzer to separate closely spaced spectral components and display them individually. Resolution of equal amplitude components is determined by resolution bandwidth. Resolution of unequal amplitude signals is determined by resolution bandwidth and bandwidth selectivity.

frequency response The peak-to-peak variation in the displayed signal amplitude over a specified center frequency range. Frequency response is typically specified in terms of \pm dB relative to the value midway between the extremes. It also may be specified relative to the calibrator signal.

frequency span The magnitude of the displayed frequency component. Span is represented by the horizontal axis of the display. Generally, frequency span is given as the total span across the full display. Some analyzers represent frequency span (scan width) as a per-division value.

frequency stability Stability is the ability of a frequency component to remain unchanged in frequency or amplitude over short- and long-term periods of time. Stability refers to the local oscillator's ability to remain fixed at a particular frequency over time. The sweep ramp that tunes the local oscillator influences where a signal appears on the display. Any long-term variation in local oscillator frequency (drift) with respect to the sweep ramp causes a signal to shift its horizontal position on the display slowly. Shorter-term local oscillator instability can appear as random FM or phase noise on an otherwise stable signal.

front-panel key Keys, typically labeled, located on the front panel of an instrument. The key labels identify the function of the key. Numeric keys and step keys are two examples of front-panel keys.

full span A mode of operation in which the analyzer scans the entire frequency band of an analyzer.

function The action or purpose that a specific item is intended to perform or serve. The analyzer contains functions that can be executed via front-panel key selections, or through programming commands. The characteristics of these functions are determined by the firmware in the instrument. In some cases, a DLP (downloadable program) execution of a function allows you to execute the function from front-panel key selections.

gain compression

The signal level at the input mixer of an analyzer where the displayed amplitude of the signal is a specific number of dB too low due just to mixer saturation. The signal level is generally specified for 1 dB or 0.5 dB compression and is usually between -3 dBm and -10 dBm.

hard copy Information or data printed onto paper as opposed to its being stored on disk or in the instrument's memory.

hardkeys Pushbutton keys on the analyzer front panel that control frequency, span, amplitude, instrument state, markers, controls, and data functions.

HP-IB The abbreviation for Hewlett-Packard Interface Bus. It is a Hewlett-Packard proprietary parallel interface that allows you to connect more than one device to a port on a computer or instrument. The HP-IB bus is also called the IEEE-488 bus (GPIB).

incrementally related carriers Incrementally related carriers (IRC), is a tune configuration where all channels except channels 5 and 6 are standard channels (see **standard tune configuration** for a definition of standard channels).

input attenuator An attenuator (also called an RF attenuator) between the input connector and the first mixer of an analyzer. The input attenuator is used to adjust the signal level incident to the first mixer, and to prevent gain compression due to high-level or broadband signals. It is also used to set the dynamic range by controlling the degree of internally-generated distortion. For some analyzers, changing the input attenuator settings changes the vertical position of the signal on the display, which then changes the reference level accordingly. In Agilent Technologies microprocessor-controlled analyzers, the IF gain is changed to compensate for changes in input attenuator settings. Because of this, the signals remain stationary on the display, and the reference level is not changed.

input impedance The terminating impedance that the analyzer presents to the signal source. The nominal impedance for RF and microwave analyzers is usually 50Ω . For some systems, such as cable TV, 75Ω is standard. The degree of mismatch between the nominal and actual input impedance is called the VSWR (voltage standing wave ratio).

integer number A

whole number with no decimal or fractional part.

IRC See **incrementally related carriers**.

limit line A test limit made up of a series of line segments, positioned according to frequency and amplitude within the analyzer's measurement range. Two defined limit lines may be displayed simultaneously. One sets an upper test limit, the other sets a lower test limit. Trace data can be compared with the limit lines as the analyzer sweeps. If the trace data exceeds either the upper or lower limits, the analyzer displays a message or sounds a warning, indicating that the trace failed the test limits.

limit-line file The user-memory file that contains the limit-line table entries. Limit lines are composed of frequency and amplitude components that make up a trace array and this data is stored in the file. The limit-line file feature is available on analyzers that are capable of limit-line operation. Refer also to **limit line**.

limit-line table The line segments of a limit line are stored in the limit-line table. The table can be recalled to edit the line segments, then restored in the limit-line file. Refer also to **limit line**.

log display The display mode in which vertical deflection is a logarithmic function of the input-signal voltage. Log display is also referred to as logarithmic mode. The display calibration is set by selecting the value of the top graticule line (reference level), and scale factor in volts per division. On Agilent Technologies analyzers, the bottom graticule line represents 0 volts for scale factors of 10 dB/division or more. The bottom division, therefore, is not calibrated for those analyzers. Analyzers with microprocessors allow reference level and marker values to be indicated in dBm, dBmV, dB μ V, volts, and occasionally in watts. Nonmicroprocessor-based analyzers usually offer only one kind of unit, typically dBm.

marker A visual indicator we can place anywhere along the displayed trace. A marker readout indicates the absolute value of the trace frequency and amplitude at the marked point. The amplitude value is displayed with the currently selected units.

maximum input level

The maximum signal power that may be safely applied to the input of an analyzer. Typically 1 W (–30 dBm) for Agilent Technologies analyzers.

maximum BW Carrier to noise measures noise in a 30 kHz resolution bandwidth and then calculates up to the measured BW which is set by default to 4 MHz.

measurement range

The ratio, expressed in dB, of the maximum signal level that can be measured (usually the maximum safe input level) to the lowest achievable average noise level. This ratio is almost always much greater than can be realized in a single measurement. Refer also to **dynamic range**.

memory

A storage medium, device, or recording medium into which data can be stored and held until some later time, and from which the entire original data may be retrieved.

menu The analyzer functions that appear on the display and are selected by pressing front-panel keys. These selections may evoke a series of other related functions that establish groups called menus.

normalized reference level An amplitude level representing 0 dB deviation from a calibrated system's response. It is obtained by subtracting the system's response from itself.

normalized reference position The position on a network analyzer's display of the normalized reference level.

off-the-air tune configuration The tune configuration for signals that are broadcast over the air and received with an antenna.

over-the-air tune configuration See **off-the-air tune configuration**.

oven reference An analyzer that has an oven reference has increased absolute frequency-reference accuracy because the internal oscillators are phase-locked to an internal precision-frequency reference.

parameter units

Standard units of measure, which include the following:

Table 1

Measured Parameter	Unit Name	Unit Abbreviation
frequency	hertz	Hz
power level	decibel relative to milliwatts	dBm
power ratio	decibel	dB
voltage	volt	V
time	second	s
electrical current	ampere	A
impedance (resistance)	ohm	Ω

personality Applications available on a memory card or other electronic media that extends the capability of an instrument for specific uses. Examples include digital radio personalities and cable TV personalities.

preamplifier An external, low-noise-figure amplifier that improves system (preamplifier/ analyzer) sensitivity over that of the analyzer itself. Some analyzers have optional internal preamplifiers.

query Any analyzer programming command having the distinct function of returning a response. These commands may end with a question mark (?). Query commands return information either to the computer or to the analyzer display.

real number A positive or negative number with both a decimal and a fractional part.

reference level The calibrated vertical position on the display used as a reference for amplitude measurement in which the amplitude of one signal is compared with the amplitude of another regardless of the absolute amplitude of either.

reference trace The trace previously taken and later compared to the currently displayed trace. For example, a trace taken at the headend for system frequency response measurements.

resolution Refer to **frequency resolution**.

resolution bandwidth The ability of an analyzer to display adjacent responses discretely (hertz, hertz decibel down). This term is used to identify the width of the resolution bandwidth filter of an analyzer at some level below the minimum insertion-loss point (maximum deflection point on the display). The 3 dB resolution bandwidth is specified; for others, it is the 6 dB resolution bandwidth.

scale factor The per-division calibration of the vertical axis of the display.

scrambled To alter an electronic signal so that a decoding device is necessary to receive the signal.

shape factor Refer to **bandwidth selectivity**.

single-sweep mode The analyzer sweeps once when trigger conditions are met. Each sweep is initiated by pressing an appropriate front-panel key, or by sending a programming command.

softkey Key labels displayed on a screen or monitor that are activated by mechanical keys surrounding the display or located on a keyboard. Softkey selections usually evoke menus that are written into the program software. Front-panel key selections determine which menu (set of softkeys) appears on the display.

span Span equals the stop frequency minus the start frequency. The span setting determines the horizontal-axis scale of the analyzer display.

span accuracy The uncertainty of the indicated frequency separation of any two signals on the display.

spectrum analyzer A device that effectively performs a Fourier transform and displays the individual spectral components (sine waves) that constitute a time-domain signal.

standard tune configuration The tune configuration in which the channels are at the frequencies that the Electronic Industries Association (EIA) and FCC define to be the standard channel frequencies.

STD See **standard tune configuration**.

stop/start frequency Terms used in association with the stop and start points of the frequency measurement range. Together they determine the span of the measurement range.

synchronization pulse

A transmitted pulse that is used to synchronize the electron beam of a picture monitor with the modulation of the transmission source.

syntax The grammar rules that specify how commands must be structured for an operating system, programming language, or applications.

system frequency response Frequency response test that measures the flatness of the entire system.

trace

A trace is made up of a series of data points containing frequency and amplitude information. The series of data points is often referred to as an array. Traces A, B, and C are the typical names of traces that the analyzer displays. The number of traces is specific to the instrument.

tune configuration Tune configuration refers to the correlation between the channel numbers and the frequency to which a channel is assigned. For example, the frequency at which channel 1 is broadcast differs between the HRC and IRC tune configurations. The E1799A Option H01 Cable TV Measurement Suite can be configured for four different tune configurations — STD, AIR, IRC, and HRC.

units

Dimensions on the measured quantities. Units usually refer to amplitude quantities because they can be changed. In analyzers with microprocessors, available units are dBm (dB relative to 1 mW dissipated in the nominal input impedance of the analyzer), dBmV (dB relative to 1 mV), dB μ V (dB relative to 1 μ V), volts, and, in some analyzers, watts.

unscrambled A signal that has not been scrambled. An unscrambled signal does not need a decoder to receive the signal correctly.

update To make existing information current; to bring information up to date.

variable A variable can be assigned a value. The value assigned to a variable can be changed.

video A term describing the output of an analyzer's envelope detector. The frequency range extends from 0 Hz to a frequency that is typically well beyond the widest resolution bandwidth available in the analyzer. However, the ultimate bandwidth of the video chain is determined by the setting of the video filter. Video is also a term describing the television signal composed of visual carriers/modulation.

video average

The digital averaging of analyzer trace information. It is available only on analyzers with digital displays. Each point on the display is averaged independently and the average is computed based on the number of sweeps selected by the user. The averaging algorithm applies a factor to the amplitude value of a given point on the current sweep ($1/n$, where n is the number of the current sweep); applies another factor to the previously stored average [$(n - 1/n)$]; and combines the two for a current average. After the designated number of sweeps are completed, the factors remain constant, and the display becomes a running average.

video bandwidth The cut-off frequency (3 dB point) of an adjustable low-pass filter in the video circuit. When the video bandwidth is equal to or less than the resolution bandwidth, the video circuit cannot fully respond to the more rapid fluctuations of the output of the envelope detector. The result is a smoothing of the trace, or a reduction in the peak-to-peak excursion, of broadband signals such as noise and pulsed RF when viewed in broadband mode. The degree of averaging or smoothing is a function of the ratio of the video bandwidth to the resolution bandwidth.

video filter A post-detection, low-pass filter that determines the bandwidth of the video amplifier. It is used to average or smooth a trace. Refer also to **video bandwidth**.

visual carrier The visual carrier is the portion of a television signal that contains the picture. A television signal contains both a visual and an aural carrier.

white level The minimum RF level of a visual carrier that corresponds to the maximum level of the white area for a picture signal.

zero span The case in which an analyzer's local oscillator remains fixed at a given frequency so that the analyzer becomes a fixed-tuned receiver. In this state, the bandwidth is equal to the resolution bandwidth. Signal amplitude variations are displayed as a function of time. To avoid loss of signal information, the resolution bandwidth must be as wide as the signal bandwidth. To avoid any smoothing, the video bandwidth must be set wider than the resolution bandwidth.